

WALCHEM

An Iwaki America Company

WNI410/411 Electroless Nickel Controllers

WNI410/411 Series Electroless Nickel Controller Instruction Manual

Five Boynton Road Hopping Brook Park Holliston, MA 01746 USA

TEL: 508-429-1110 FAX: 508-429-7433 WEB: www.walchem.com

Notice

© 2012 WALCHEM, An Iwaki America Incorporated Company (hereinafter "Walchem")
5 Boynton Road, Holliston, MA 01746 USA
(508) 429-1110
All Rights Reserved
Printed in USA

Proprietary Material

The information and descriptions contained herein are the property of WALCHEM. Such information and descriptions may not be copied or reproduced by any means, or disseminated or distributed without the express prior written permission of WALCHEM, 5 Boynton Road, Holliston, MA 01746.

This document is for information purposes only and is subject to change without notice.

Statement of Limited Warranty

WALCHEM warrants equipment of its manufacture, and bearing its identification to be free from defects in workmanship and material for a period of 24 months for electronics and 12 months for mechanical parts and electrodes from date of delivery from the factory or authorized distributor under normal use and service and otherwise when such equipment is used in accordance with instructions furnished by WALCHEM and for the purposes disclosed in writing at the time of purchase, if any. WALCHEM's liability under this warranty shall be limited to replacement or repair, F.O.B. Holliston, MA U.S.A. of any defective equipment or part which, having been returned to WALCHEM, transportation charges prepaid, has been inspected and determined by WALCHEM to be defective. Replaceable elastomeric parts and glass components are expendable and are not covered by any warranty.

THIS WARRANTY IS IN LIEU OF ANY OTHER WARRANTY, EITHER EXPRESS OR IMPLIED, AS TO DESCRIPTION, QUALITY, MERCHANTABILITY, FITNESS FOR ANY PARTICULAR PURPOSE OR USE, OR ANY OTHER MATTER..

180366.D
May 2012

TABLE OF CONTENTS

1.0	INTRODUCTION.....	1
2.0	SPECIFICATIONS	2
2.1	Measurement Performance	2
2.2	Electrical: Input/Output	2
2.3	Mechanical.....	2
2.4	WNI Variables and their Limits	3
3.0	UNPACKING & INSTALLATION.....	4
3.1	Unpacking the unit.....	4
3.2	Mounting the electronic enclosure.....	4
3.3	Flow Through Nickel Sensor/Sample Loop Installation.....	4
3.4	Icon Definitions	10
3.5	Electrical installation	10
4.0	FUNCTION OVERVIEW	14
4.1	Front Panel	14
4.2	Display	14
4.3	Keypad.....	15
4.4	Access Code.....	15
4.5	Startup	15
4.6	Shut Down	16
5.0	OPERATION.....	17
5.1	Main Menu	17
5.2	Sensor Menu.....	19
5.3	pH Input Menu	21
5.4	Temperature Menu	23
5.5	Output 1 Menu	25
5.6	Output 2 and 3 Menus	28
5.7	pH Output (Output 3) Menu	30
5.8	Output 4 and Alarm Menus.....	33
5.9	4-20 mA 1 and 2 Menus (Optional).....	37
5.10	Time Menu	38
5.11	Access Code Menu.....	39
5.12	Datalog Menu.....	40
5.13	Config Menu.....	42
5.14	Upgrade Menu	44
6.0	MAINTENANCE	45
6.1	Nickel Sensor Cleaning	45
6.2	pH Electrode Maintenance	45
6.3	Replacing the Fuses	46
7.0	TROUBLESHOOTING	47
7.1	Error Messages.....	47
8.0	SERVICE POLICY	51

1.0 INTRODUCTION

The WNI410 series nickel controllers are optoelectronic on-line analyzers that may be used in variety of applications including electroless nickel baths and a number of other chemistries that contain more than 0.10 grams/liter (g/L) of nickel ions. Because the sensors are made with glass, do not use these controllers in baths that contain fluorides.

Four control relays are available that may be set up to feed chemicals, or as alarms. A fifth relay is used as a diagnostic alarm. Output 3 may be used for pH control if the optional pH input board is installed. One or two isolated 4-20 mA outputs that are proportional to the nickel concentration are optional.

Any set point may be viewed without interrupting control. Each set point change will take effect as soon as it is entered. An access code is available to protect set point parameters, while still allowing settings to be viewed.

Our unique USB feature provides the ability to upgrade the software in the controller to the latest version.

An advanced USB capability option is available. The Configuration file feature allows you to save all the set points from a controller onto a USB flash disk, and then import them into another controller, making the programming of multiple controllers fast and easy. The data logging feature allows you to save the last 2 month's readings and events to a USB flash disk.

2.0 SPECIFICATIONS

2.1 Measurement Performance

Electroless Nickel Concentration Range	0.1 - 25 g/L (0.01 – 3.32 oz/gal)
Nickel Concentration Resolution	0.001 g/L (0.0001 oz/gal)
Nickel Concentration Accuracy	±0.01 g/L (0.001 oz/gal)
Optional pH Input Range	0 – 14 pH
Optional pH Resolution	0.01 pH
Optional pH Accuracy	Electrode and calibration dependant
Optional pH Automatic Temperature Compensation	Pt100 or Pt1000
Temperature Range	0-100°C (32-212°F)
Temperature Resolution	0.05°C (0.09°F)
Temperature Accuracy	±0.1°C (±0.18°F)

2.2 Electrical: Input/Output

Input Power	100-240 VAC, 50/60 Hz, 8A Fuse: 1.0 ampere, 5 x 20 mm
Input Signals	
Nickel Sensor Signal	0 to 2VDC
pH (optional)	±500 mV
Interlock (optional)	Isolated, dry contact closure required (i.e., flow, level, etc.)
Outputs	
Mechanical Relays (5)	Internally powered relays switching line voltage 6 A (resistive), 1/8 HP All relays are fused together as one group, total current for this group must not exceed 6A
<i>Note:</i> The Alarm relay is non-programmable as to responding to diagnostic alarms. Refer to the Main Menu diagram for the list of error conditions that trigger the alarm relay.	
4 - 20 mA (1 or 2 optional)	Internally powered Fully isolated 600 Ohm max resistive load Resolution .001% of span Accuracy ± 1% of reading
Nickel Sensor Power	+ 5VDC, 150 mA
Optional pH Sensor Power	±5V DC, 5 mA
Agency Approvals	
UL	ANSI/UL 61010-1:2004, 2 nd Edition*
CAN/CSA	C22,2 No.61010-1:2004, 2 nd Edition*
CE Safety	EN 61010-1:2001 2 nd Edition *
CE EMC	EN 61326-1:2006

Note: For EN61000-4-6, EN61000-4-3 the controller met performance criteria B.

*Class A equipment: Equipment suitable for use in establishments other than domestic, and those directly connected to a low voltage (100-240 VAC) power supply network which supplies buildings used for domestic purposes.

2.3 Mechanical

Controller Specifications

Enclosure Material	Polycarbonate
NEMA Rating	NEMA 4X
Dimensions	8.5" x 6.5" x 5.5"
Display	2 x 16 character backlit liquid crystal
Operating Ambient Temp	32 – 122°F (0 – 50°C)
Storage Temperature	-20 – 180°F (-29 – 80°C)

Sensor Specifications

Enclosure	ABS
Wetted Materials:	Polyethylene, glass, FKM
Dimensions:	6.75" x 4.75" x 2.25"
Operating Ambient Temperature	32 - 122°F (0 - 50°C)
Storage Temperature:	-40 to 185°F (-40 to 85°C)
Solution Temperature:	200°F (93°C) max.
Maximum Cable Length	80 feet (25 meters)

2.4 WNI Variables and their Limits

	Low Limit	High Limit
Sensor menu		
Days Between Calibration	0 days (no reminder)	59 days
1 Point Calibration Offset	± 0.01 g/l, 0.001 oz/gal	± 0.45 g/l, 0.045 oz/gal
pH Input Menu (WNI411 only)		
Days Between Calibration	0 days (no reminder)	59 days
1 Point Calibration Offset	± 0.01 pH	± 0.99pH
Temperature Menu (WNI411 only)		
	No variables	
Output 1 -4 Menus		
Set Point	0 (units set by user)	99.99 g/l, 9.999 oz/gal
High or Low Alarm Point	0 (units set by user)	99.99 g/l, 9.999 oz/gal
Dead Band	0 (units set by user)	2.01 g/l, 0.201 oz/gal
Time Limit (set in min:sec)	0:01	59:59 (enabled) 0=unlimited (disabled)
Pump Rate	0.01 (units set by user)	100.01 (units set by user)
Turnover Limit	1 metal turnover	99 metal turnovers
Turnover Volume	1 (units set by user)	9999 (units set by user)
pH Output Menu (WNI411 only)		
High or Low Set Point	0.01 pH	14.00 pH
Dead Band	0.01 pH	1.99 pH
Time Limit (set in min:sec)	0:01	59:59 (enabled) 0=unlimited (disabled)
Alarm Menu		
High or Low Alarm Point	0 (units set by user)	99.99 g/l, 9.999 oz/gal
Dead Band	0 (units set by user)	2.01 g/l, 0.201 oz/gal
Time Limit (set in min:sec)	0:01	59:59 (enabled) 0=unlimited (disabled)
4-20 mA_1 or 2 Menus		
4 & 20 mA Settings, Ni	0 (units set by user)	99.99 g/l, 9.999 oz/gal
4 & 20 mA Settings, pH (WNI411 only)	0 pH	14 pH
Access Code Menu		
New Value	0	9999
Datalog Menu (Optional)		
	No variables	
Config Menu (Optional)		
	No variables	
Upgrade Menu		
	No variables	

*Note: The Alarm relay is non-programmable as to responding to diagnostic errors. Refer to the Main Menu diagram for the list of error conditions that trigger the alarm relay.

3.0 UNPACKING & INSTALLATION

3.1 Unpacking the unit

Inspect the contents of the carton. Please notify the carrier immediately if there are any signs of damage to the controller or its parts. Contact your distributor if any of the parts are missing. The carton should contain: a WNI series controller and instruction manual. Any options or accessories will be incorporated as ordered.

3.2 Mounting the electronic enclosure

The WNI series controller is supplied with mounting holes on the enclosure. It should be wall mounted with the display at eye level, on a vibration-free surface, utilizing all four mounting holes for maximum stability. Use M6 (1/4" diameter) fasteners that are appropriate for the substrate material of the wall. The enclosure is NEMA 4X rated. The maximum operating ambient temperature is 122°F (50°C); this should be considered if installation is in a high temperature location. The enclosure requires the following clearances:

Top:	2" (50 mm)
Left:	8" (203 mm)
Right:	4" (102 mm)
Bottom:	7" (178 mm)

3.3 Flow Through Nickel Sensor/Sample Loop Installation

The nickel flow through sensor is designed for out-of-tank monitoring of electroless nickel solutions.

The sensor is designed with a glass tube that contains the nickel solution that forms a fixed path length between the lamp and receptor module. The solution absorbs light at specific wavelengths in proportion to the nickel concentration. In order to avoid a shift in calibration caused by condensation, the sensor cover should NEVER be removed!

The flow through sensor is provided with a mounting plate and 20 feet of cable. Extension cable is available if the sensor cannot be placed within 20 feet of the controller. The maximum cable length is 80 feet. Always route AC voltage wiring in conduit that is separated a minimum of 6 inches from low voltage DC signal lines (such as the sensor signal).

The sample loop consists of a shut off valve, a cooling coil or plate, a sensor, an optional pH adapter assembly, a pump, or any combination thereof. The shut off valve is to quickly isolate the system if necessary. A cooling coil or plate is necessary to cool the nickel solution down to a temperature acceptable to a sample pump and/or pH electrode (if applicable). Cooling the solution is also recommended to help reduce the amount of plate-out that may form in the sample loop. The pH adapter assembly is used to mount an in-line pH electrode. It should be mounted such that the electrode is always immersed in the 'U' trap. The pump may be either a stand-alone sample pump (which will typically have high temperature restrictions), or a high temperature pump (which is usually a branch off of the recirculation pump).

The flow through sensor/sample loop must be installed according to the following guidelines:

- Mount the sensor on a vibration-free, vertical surface so that the sensor tubing inlet connection is at the bottom and the outlet is at the top. The vertical orientation will prevent air bubbles from being trapped in the sensor.

- Install a shut-off valve at the beginning of the sample loop so that the system may be shut off quickly if necessary.
- If a sample pump is to be used, it must be installed last, after the cooling coil or cooling plate, the flow through sensor, and the pH adapter assembly, if applicable.
- If a high temperature recirculation pump is to supply flow, adjust flow rate through the sample loop between 400 - 500 mL/min (approx. 0.11 - 0.13 gal/min). This flow rate will help ensure adequate cooling of the solution while maintaining a reasonable lagtime in longer runs of tubing. If this is not possible or is undesirable, see Application Notes below.

Other installation guidelines that may be helpful in the overall system:

- Mount the sensor as close to solution as possible. Keep tubing distances to the sensor inlet as short as possible to avoid hydraulic lag time. Maximum recommended length of tubing from solution to sensor is 25 feet. If this is not possible, see Application Notes below.
- The solution inlet should draw sample from an area of good solution movement in order to respond quickly to chemical additions. However, the solution inlet should *not* draw too near to where the chemistry is added to avoid artificial 'spikes' in concentration.
- The solution discharge should be open to atmospheric pressure in order to ensure proper flow.
- The cable connector to the controller is keyed, do not force!

Application Notes

If the distance from the solution to the sensor is further than the recommended length of 25 feet, the maximum lagtime must be calculated from the desired control band to determine a pump flow rate based on a given distance of standard, uniform tubing. The maximum lagtime is the maximum allowable time for the solution to continuously get to the sensor in order to achieve the desired control band.

To calculate maximum lagtime:

$$\text{Max. Lagtime} = \frac{\text{Desired Control Band}^*}{4 \times \text{Depletion Rate}}$$

where Control band = Maximum deviation of concentration

Depletion rate = Rate at which the bath will deplete per unit of time

The deadband should be adjusted so that it is 1/4 the desired control band.

For Example: The set point is 4.00 g/L.

If the desired control band is 0.20 g/L (± 0.10 g/L or 2.5%) and the bath is depleting at a rate of 1.25 g/L every 15 minutes (0.08333 g/L every minute),

$$\text{then Max. Lagtime} = \frac{0.20 \text{ g/L}}{4 \times (0.08333 \text{ g/L /min})} = 0.60 \text{ minutes}$$

So, 0.60 minutes is the maximum time it should take for the solution to reach the sensor.

To calculate pump flow rate:

$$\text{Minimum Pump Flow Rate} = \frac{\text{Volume of System}^*}{\text{Maximum Lagtime}}$$

where $\text{Volume of system} = \pi \left(\frac{\text{Tubing I.D.}}{2} \right)^2 \times \text{Length of tubing}$

Maximum lagtime = Previously calculated time to get solution to sensor.

* Volume is based on length from solution to sensor, not the return.

For Example: If the system parameters are: Tubing is 3/8" O.D. ' 1/4" I.D.
Length is 30 feet (360 inches)

$$\begin{aligned} \text{then the volume of the system} &= \pi \left(\frac{0.25 \text{ in}}{2} \right)^2 \times (360 \text{ in}) \\ &= 17.7 \text{ in}^3 \end{aligned}$$

Note: 1 U.S. Gallon = 231 U.S cubic inches	1 Liter = 61.03 U.S. cubic inches
Volume of Cooling Coil: 0.018 Gallons 0.068 Liters	Volume of Cooling Plate: 0.023 Gallons 0.088 Liters
Volume of 3/8" O.D. x 1/4" I.D. (0.59 in ³ /ft): 0.00255 Gallons/linear ft 0.00965 Liters/linear ft	

$$\text{Volume of the system} = \frac{17.7 \text{ in}^3}{231 \text{ in}^3 / \text{gallon}} = 0.0765 \text{ gallons}$$

$$\text{Maximum lagtime} = 0.60 \text{ minutes (previously calculated)}$$

$$\text{So, the minimum pump flow rate} = \frac{0.0765 \text{ gallons}}{0.60 \text{ minutes}} = 0.127 \text{ gal/min (483 mL/min)}$$

Caution: The calculated pump flow rate is the minimum required to obtain the desired control band, however, if the flow rate increases over the recommended rate of 500 mL/min (approx. 0.13 gal/min) the rate of cooling will decrease. This may be compensated for by re-evaluating the system criteria: length / desired control band or to double up on the cooling plate/coil.

Consult factory with any further installation questions.

Installation including degasser

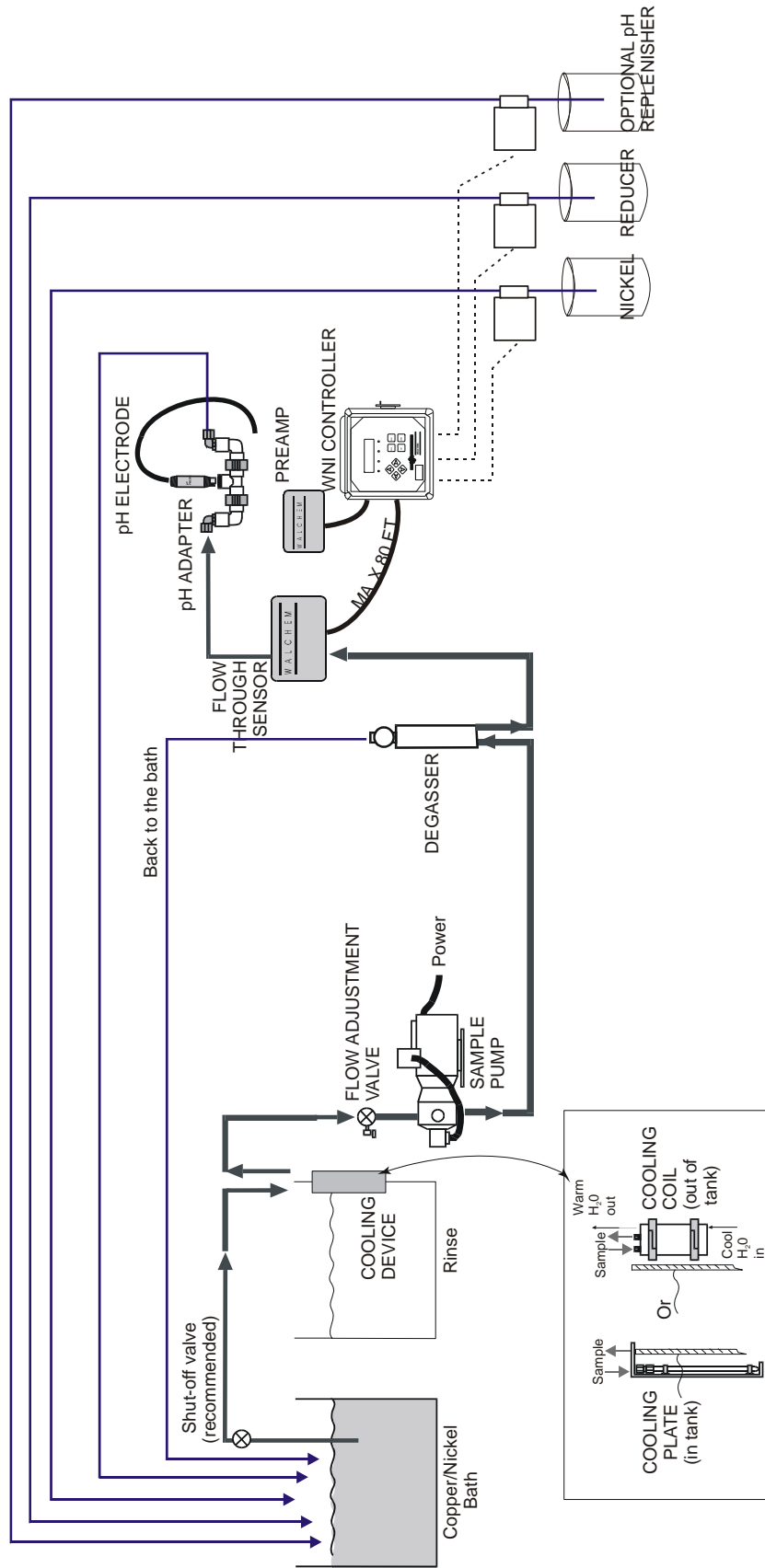

Figure 1a Typical Installation including degasser

Installation without degasser

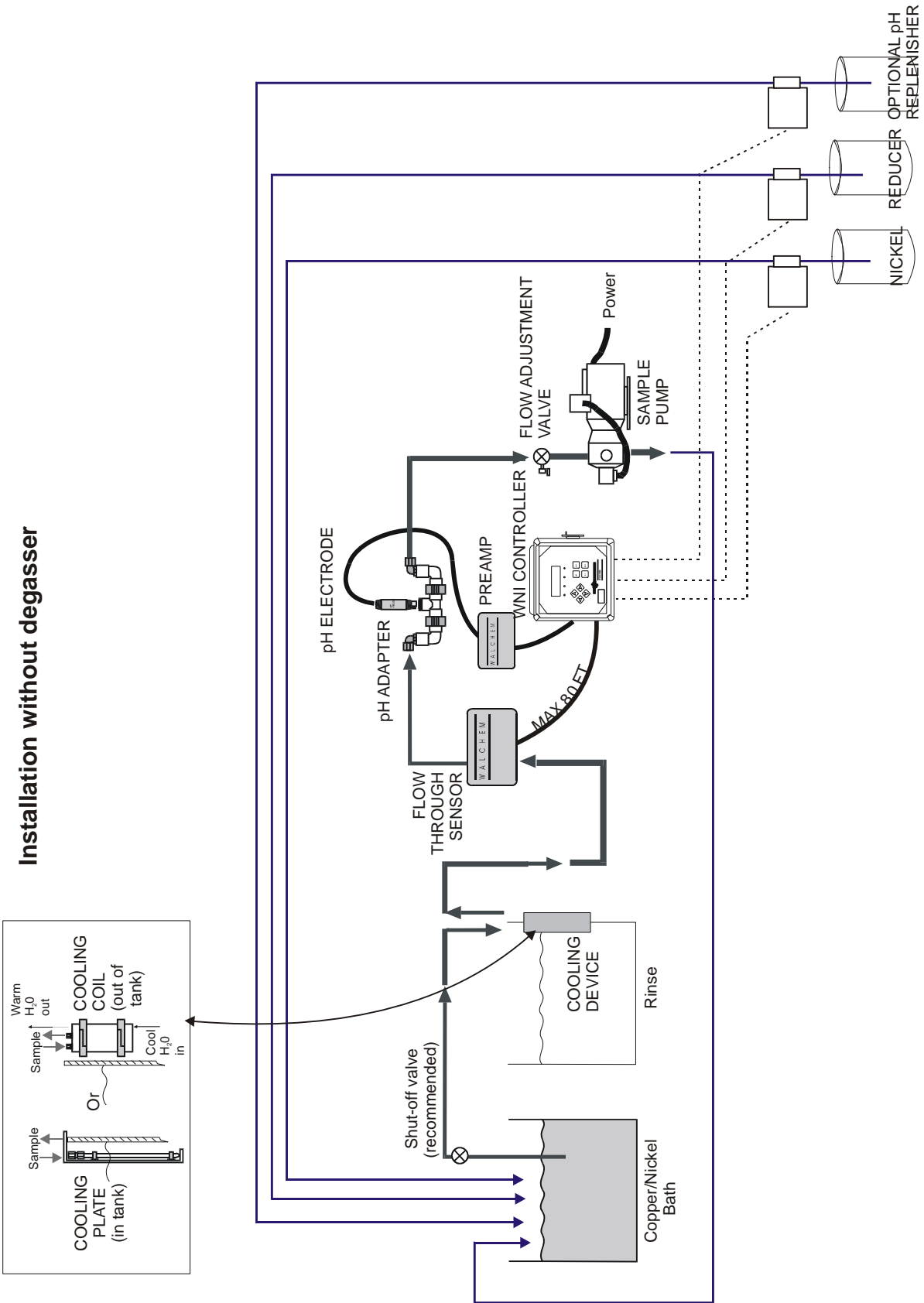

Figure 1b Typical Installation without degasser

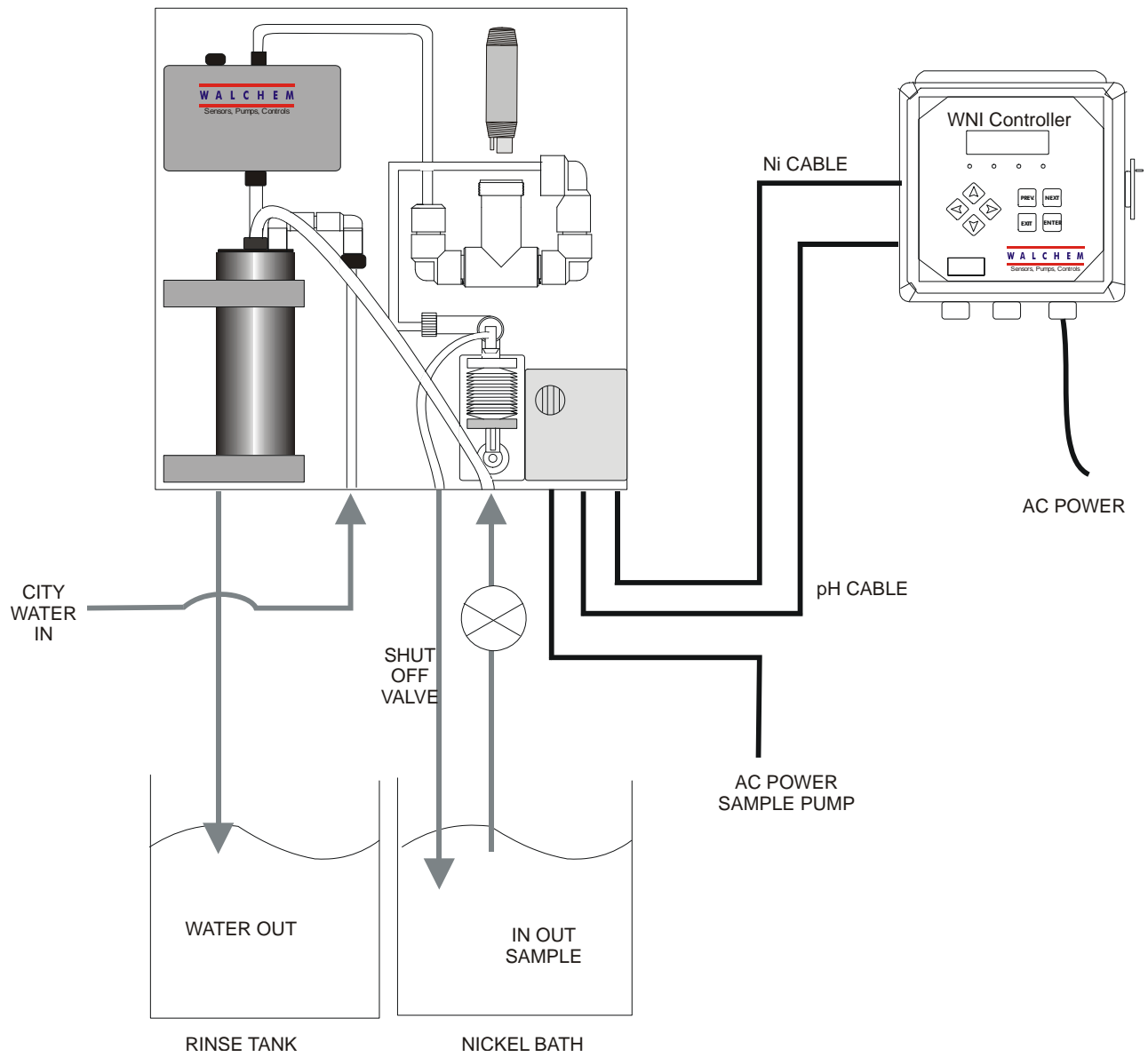







Figure 1C Electroless Nickel Sample System Installation



3.4 Icon Definitions

Symbol	Publication	Description
	IEC 417, No.5019	Protective Conductor Terminal
	IEC 417, No. 5007	On (Supply)
	IEC 417, No. 5008	Off (Supply)
	ISO 3864, No. B.3.6	Caution, risk of electric shock
	ISO 3864, No. B.3.1	Caution

3.5 Electrical installation

The various standard wiring options are shown in figure 2. Your WNI series controller will arrive from the factory prewired or ready for hardwiring. Depending on your configuration of controller options, you may be required to hardwire some or all of the input/output devices. Refer to figures 3 and 4 for circuit board layout and wiring.

Note: when wiring the optional 4-20 mA output or a remote interlock switch, it is advisable to use stranded, twisted, shield pair wire between 22-26 AWG. Shield should be terminated at the controller ground stud (see figures 3 and 4).

	CAUTION	
1.	<p>There are live circuits inside the controller even when the power switch on the front panel is in the OFF position! The front panel must never be opened before power to the controller is REMOVED!</p> <p>If your controller is prewired, it is supplied with a 8 foot, 18 AWG power cord with USA style plug. A tool (#1 Phillips driver) is required to open the front panel.</p>	
2.	<p>When mounting the controller, make sure there is clear access to the disconnecting device!</p>	
3.	<p>The electrical installation of the controller must be done by trained personnel only and conform to all applicable National, State and Local codes!</p>	
4.	<p>Proper grounding of this product is required. Any attempt to bypass the grounding will compromise the safety of persons and property.</p>	
5.	<p>Operating this product in a manner not specified by Walchem may impair the protection provided by the equipment.</p>	

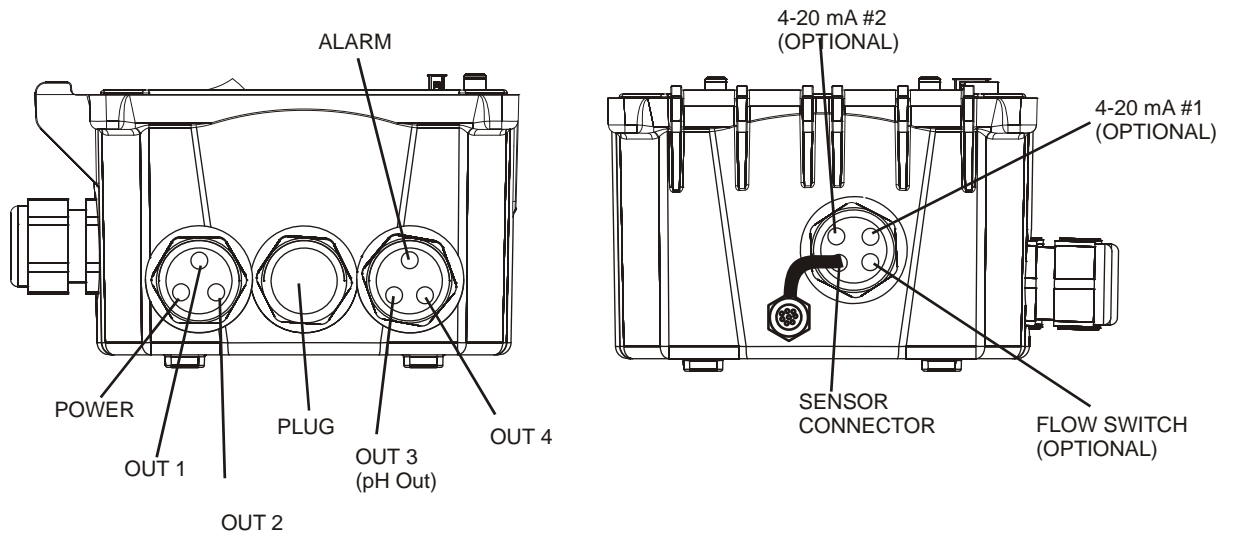

Figure 2 WNI410 Conduit Wiring

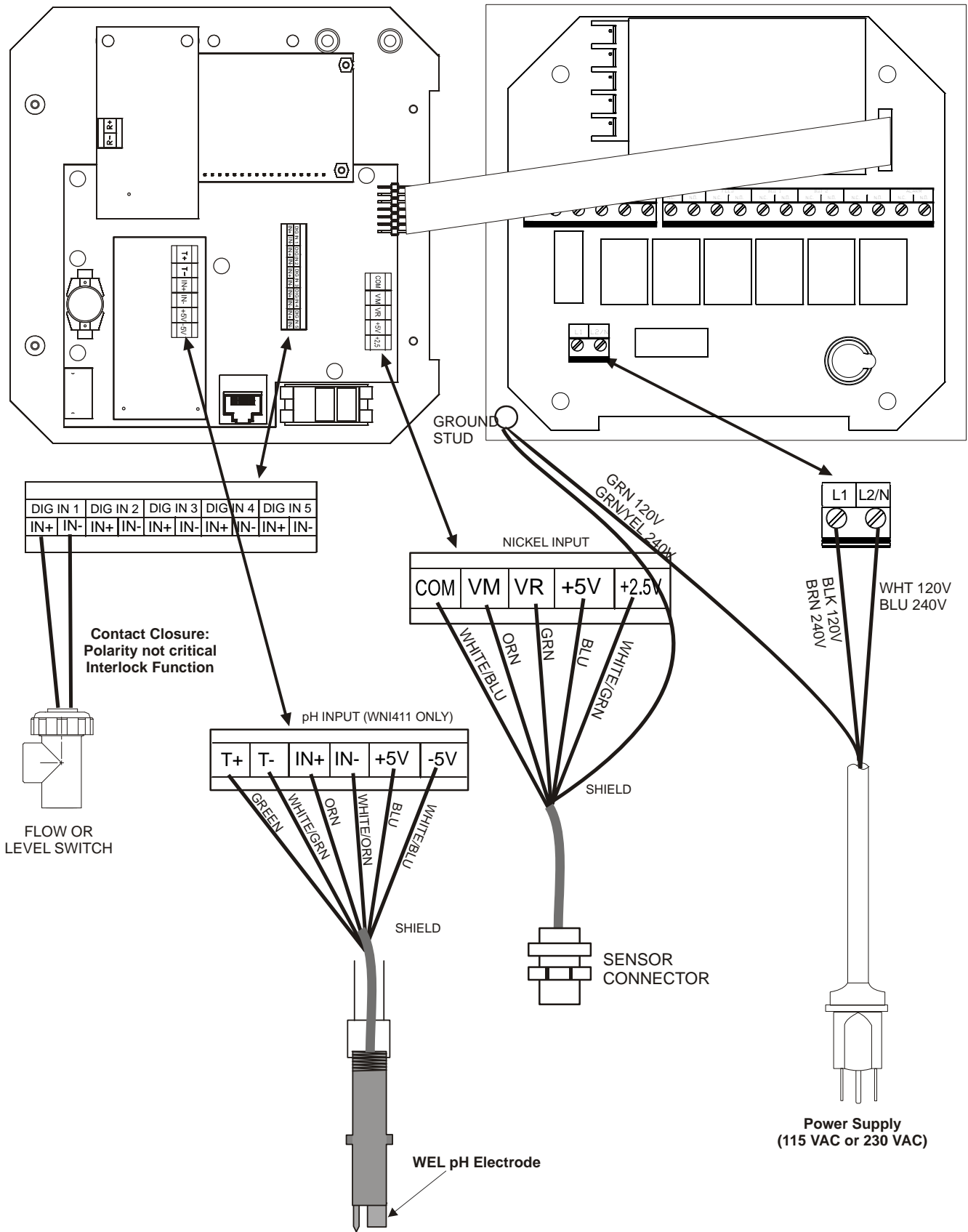

Figure 3 WNI410 Input Wiring

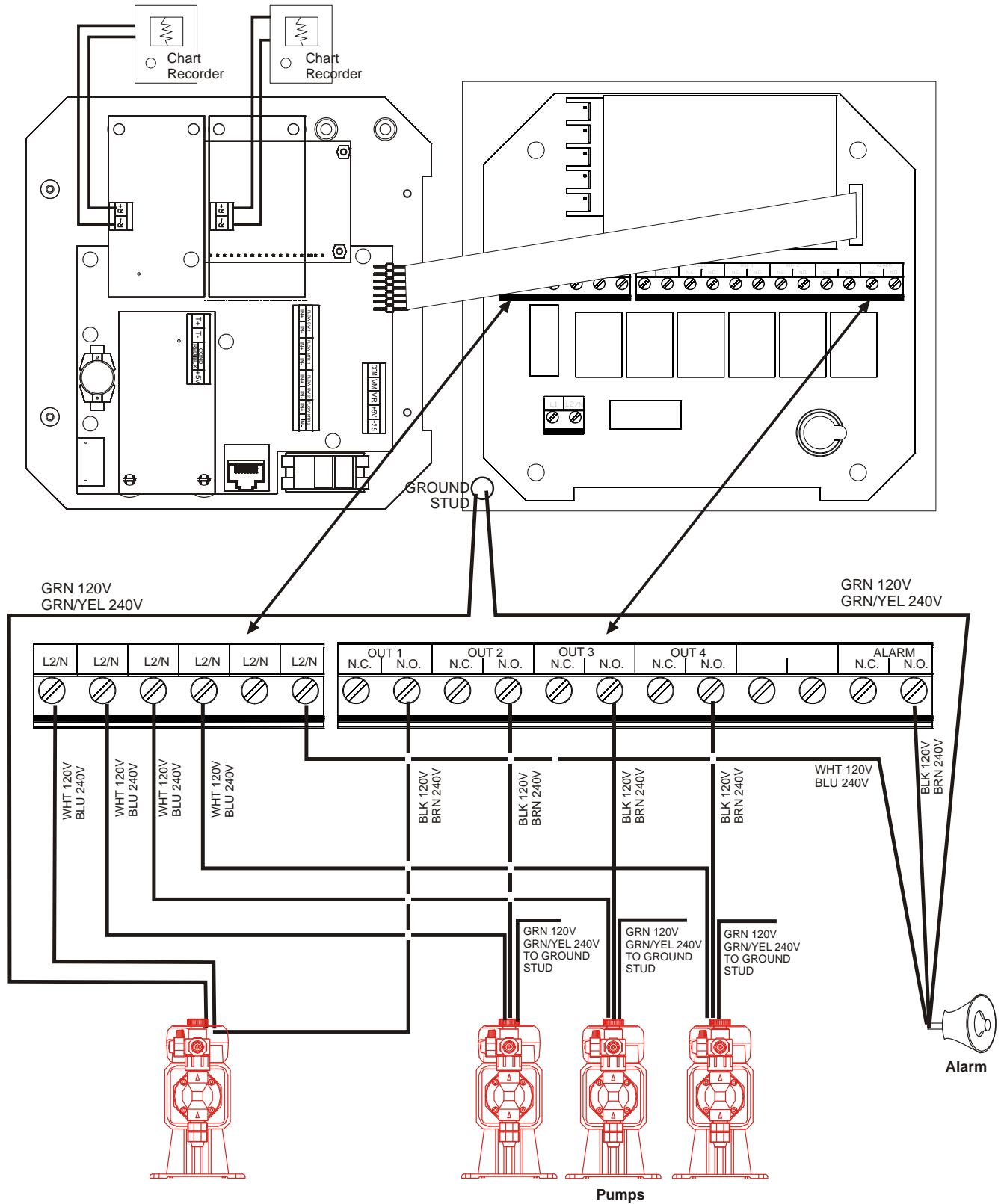

Figure 4 WNI410 Outputs

4.0 FUNCTION OVERVIEW

4.1 Front Panel

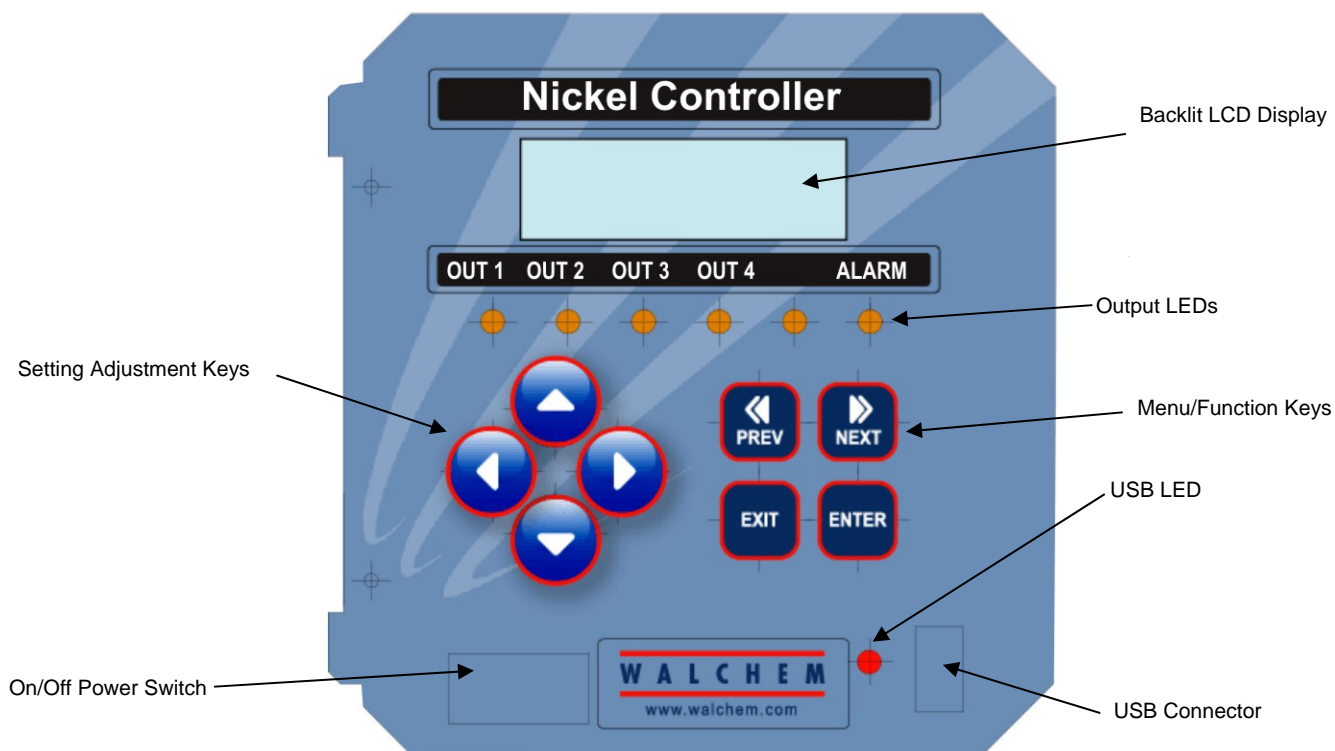

Figure 5 Front Panel

4.2 Display

A summary screen is displayed while the WNI controller is on. This display will show a bar graph of the nickel concentration relative to the set point, the actual nickel concentration value, and current operating conditions.

Towards the center of the bar graph is an (S), which represents the set point. For each 1% rise above the set point a vertical line appears to the right of the (S). For each 1% drop below the set point a vertical bar appears to the left of the (S). There are small breaks in the bars at each 5%. If high or low alarm limits are reached, then either an (H) or (L) will appear.

If you have the pH option board installed, the bar graph of nickel concentration relative to set point is not shown. In its place will be the pH reading as shown below.

The operating conditions which may be displayed on the bottom line of the display are: Control Delay 30* (number counts down), Sensor Error, Light Bulb Out, No Sample, Plate Out, Manual Output* Interlock, Output Disabled*, Pump Overrun, High/Low Alarm, Turnover Limit, Calibration Time, Outputs On* and Normal*

*These messages do not activate the diagnostic alarm relay.



Figure 6 Summary Screen

4.3 Keypad

The keypad consists of 4 directional arrow keys and 4 function keys. The arrows are used to move the adjustment cursor and change settings, while the function keys are used to enter values, and navigate the various menu screens. The function keys are **ENTER**, **EXIT**, **NEXT**, and **PREV** (previous). **NEXT** and **PREV** scroll through the various menu choices. **ENTER** is used to enter a submenu and to enter a value. **EXIT** is used to back up one menu level. If you are at the main menu level, **EXIT** will return you to the Summary Display.



To change a value in a submenu, the left/right arrow keys move the cursor left and right to each digit or option that can be changed. The up/down arrows will change numeric values up or down, or scroll through option choices. Press **ENTER** only when you have finished making all of the changes for that menu screen.

4.4 Access Code

The WNI series controller is shipped with the access code disabled. If you wish to enable it, see Section 5.7 for operation. With the access code enabled, any user can view parameter settings, but not change them. Note that this provides protection only against casual tampering. Use a lock on the cover latch if you need more protection.

4.5 Startup

Initial Startup

After having mounted the enclosure and wired the unit, the controller is ready to be started.

Plug in the controller and turn on the power switch to supply power to the unit.

The display will show the WNI series model number then revert to the top level summary screen with "Control Delay" for a status message. This message will be displayed for approximately 30 seconds. In some situations, the user may not want the unit to be controlling and possibly turning on pumps when it is first powered on. This allows you enough time to enter the Output menu and disable the outputs. The only difference in the controller operation during these 30 seconds is that it will not activate any outputs. All measurements are live and all menus are accessible. Scroll through the menus, calibrate the sensor, and set the control parameters as detailed in Section 5, Operation.

If you turn the power to the controller OFF, at the next power-up all outputs will revert back to automatic mode, where they will activate based upon the programmed set points.

Move to the “OUT 1” menu and change the set point, dead band and time limit to your desired values. Refer to Section 5.5. If you want to keep track of the volume of nickel pumped, or track metal turnovers, this is also set in the “OUT 1” menu in the “TOTAL 1” menu.

If you have the pH input option, then the set points are found in the “pH (Output 3)” menu. Refer to section 5.6.

Outputs 2 and 4 are intended for the addition of chemicals (such as hypophosphite or borohydride) in proportion to the nickel addition, so the only set points found in these menus are related to totalizing the chemical additions.

If you have the pH input option, move to the “pH Input” menu to calibrate the pH electrode. Refer to Section 5.3.

Move to the “Sensor” menu to change the units of measure and perform a “New Sensor Setup” (2 point calibration) of the nickel sensor. Refer to Section 5.2.

Alarm limits and setting the time are done in those respective menus.

If you have an optional 4-20 mA output card, you will see a menu for scaling the output signal to fit your application. Refer to Section 5.9.

To return to the “Summary” screen, you may press **EXIT** until it is displayed, or you may wait 10 minutes and the display will revert to it automatically.

Normal Startup

Startup is a simple process once your set points are in memory. Simply check your supply of chemicals, turn on the controller, calibrate it if necessary and it will start controlling.

4.6 Shut Down

To shut the WNI controller down, simply turn off the power. Programming remains in memory.

5.0 OPERATION

These units control continuously while power is applied. Programming is accomplished via the local keypad and display.

To view the top level menu, press any key. The menu structure is grouped by inputs and outputs. Each input has its own menu for calibration and unit selection as needed. Each output has its own setup menu including set points, timer values, etc. as needed. After ten minutes of inactivity in the menu, the display will return to the summary display. Keep in mind that even while browsing through menus, the unit is still controlling.

5.1 Main Menu

The exact configuration of your WNI controller determines which menus are available as you scroll through the settings. Certain menus are only available when you select certain options; which may be hardware options (like the installation of a 4-20 mA output board) or software options (like choosing to totalize on volume) or both. All settings are grouped under the following main menu items.

Sensor	
pH Input	Only if unit has pH option circuit board installed
pH Temperature	Only if unit has pH option circuit board installed
Output 1	
Output 2	
Output 3 (pH)	
Output 4	
Alarm	
Time	
4-20mA 1	Only if 4-20mA option installed
4-20mA 2	Only if 2nd 4-20mA option installed
Access Code	
Datalog	Only if advanced USB feature is in model code
Config	Only if advanced USB feature is in model code
Upgrade	

The **NEXT** key travels forward through this list while the **PREV** key travels backwards through the list. Pressing **ENTER** will Enter the lower level menu that is currently displayed.

Possible Status Screens

- * Control Delay 30
- * Sensor Error
- * pH Sensor Error
- * Temp Error
- * Light Bulb Out
- * No Sample
- * Plate Out
- * Manual Output
- * Interlock
- * Output Disabled
- * Output Timeout
- * pH Output Timeout
- * High/Low Alarm
- * pH High/Low Alarm
- * Turnover Limit
- * Calibration Time
- * Outputs On
- * pH Output On
- * Normal

* These status screens DO NOT activate the diagnostic alarm relay

Main Menu

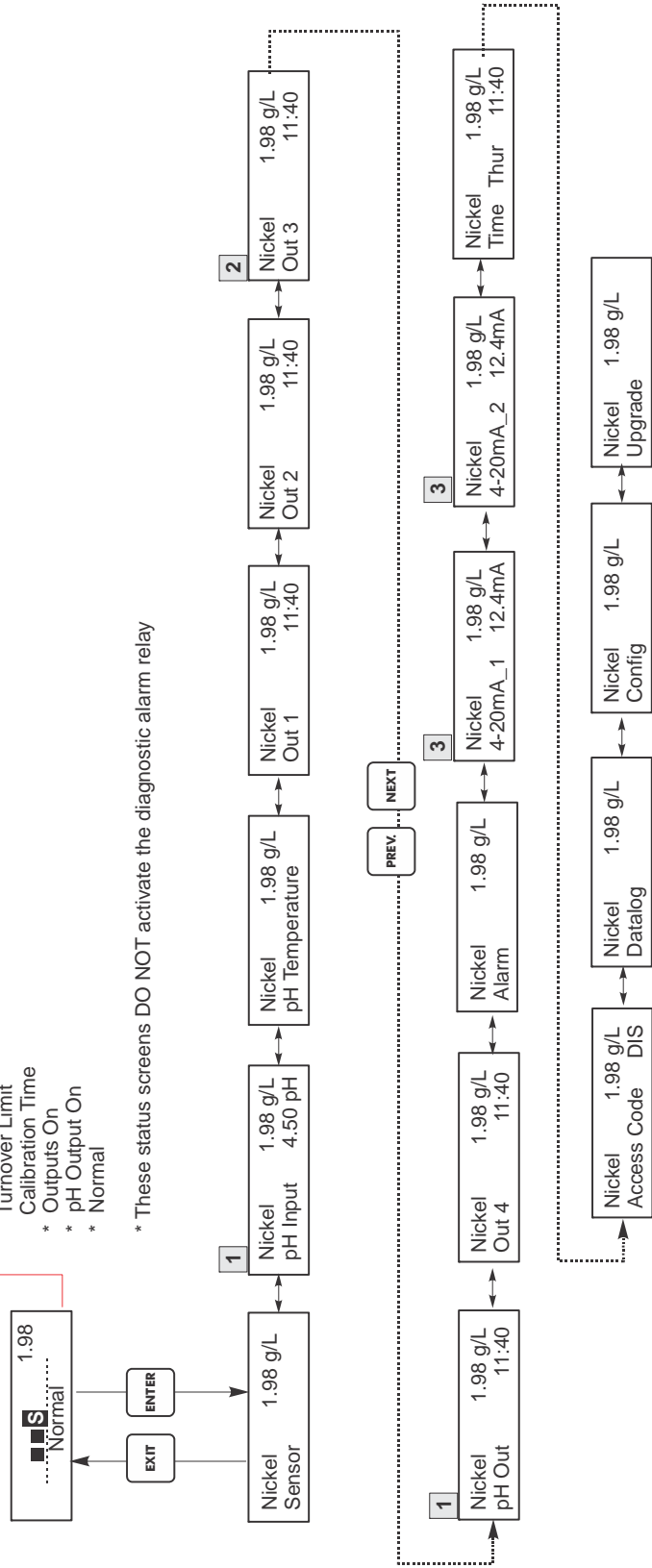

Figure 7 Main Menu

Legend

- 1 pH Input & Output menus are only present if pH option board is installed.
- 2 Menu is only present if no pH option board is installed.
- 3 4-20mA menu is only present if 4-20mA option is installed.

Operation

- Press Enter key to enter menu or submenu.
- Press Exit key to exit menu.
- After 10 minutes of inactivity the controller will automatically return to the summary screen.

5.2 Sensor Menu

The sensor menu provides the following settings: Calibration history (informational only), 2 point calibration, 1 point calibration, sensor type (range) selection, and other calibration menus. Each is discussed in detail below. Refer to the Sensor Menu chart on the next page.

Note: If you are programming the unit for the first time, press the **PREV** key once, and set the "Sensor Type" menu first to choose the range that matches the sensor you have connected. Then press **ENTER**.

Cal'd	Displays the date of the last sensor calibration.
1 Pt Calibration	<p>Press ENTER to perform a 1 point calibration of the nickel sensor. This calibration is best performed at normal operating temperature.</p> <p>Have solution flowing through the flow-through sensor. Take a sample of the solution and note the concentration displayed by the WNI controller. Carefully perform the normal laboratory analysis of the nickel concentration. Calculate the offset by subtracting the displayed value from the lab results. If the lab analysis is significantly different, adjust the offset in the 1 point calibration menu, using the arrow keys to change the value and the +/- sign. If the controller's display is higher than the lab analysis, the offset should be negative.</p> <p>The maximum offset for a one point calibration is 5 g/l(0.45 oz/gal) from the last new sensor setup value. If you have an offset larger than this, then perform a new sensor setup.</p>
New Sensor Setup	<p>Press ENTER to set up a new sensor. First you see a warning message: "WARNING Chg sensor cal? N" This acts as a safety precaution for those who may only be "browsing" through the menus. If you enter the New Sensor Setup menu, you may easily, inadvertently, change the calibration of the sensor. If you continue with the following procedures, you must recalibrate the new sensor.</p> <p>Water....xxxx.x</p> <p>Place the immersible sensor in clean tap or DI water, or circulate through the flow through sensor. When the number on the display is constant, press ENTER.</p> <p>Sample....xxxx.x</p> <p>Place the sensor in the bath at a known concentration or restart pumping the bath sample through the flow through sensor. No work should be going through the bath so that the concentration remains constant. Ideally the bath should be at the typical operating nickel concentration. When the number on the display is constant, press ENTER.</p> <p>Smpl Conc</p> <p>Use the arrow keys to change the displayed number to the actual concentration of the bath in grams/liter or ounces/gallon, depending on the unit of measure you have selected, then press ENTER.</p>
Days Btwn Cal	Use the arrow keys to set the number of days that you would like to go by before recalibrating the sensor. The controller will prompt you to recalibrate when that time has expired. Setting the number of days to zero will disable this feature.
mV in Display	This menu displays the mV from the sensor. It is useful for troubleshooting. The top line shows 2 live voltage readings from the sensor in millivolts. The bottom line shows the stored values for each sensor signal from the most recent new sensor set up calibration - specifically the signal values measured with water.
Self Test	This feature is a diagnostic tool that can help isolate a problem between the sensor and controller. Before initiating the self test, the sensor MUST be disconnected from the controller in order to function properly. When ENTER is pressed the controller disables the sensor inputs and injects 2 test signals, simulating a properly functioning sensor. The controller will display "PASS" or "FAIL" along with a live mV reading. If "PASS" is displayed then it indicates the controller is functioning properly and the problem is likely to be with the sensor. See the troubleshooting section for further details. If "FAIL" is indicated, the controller is defective. Consult your factory representative for service options.

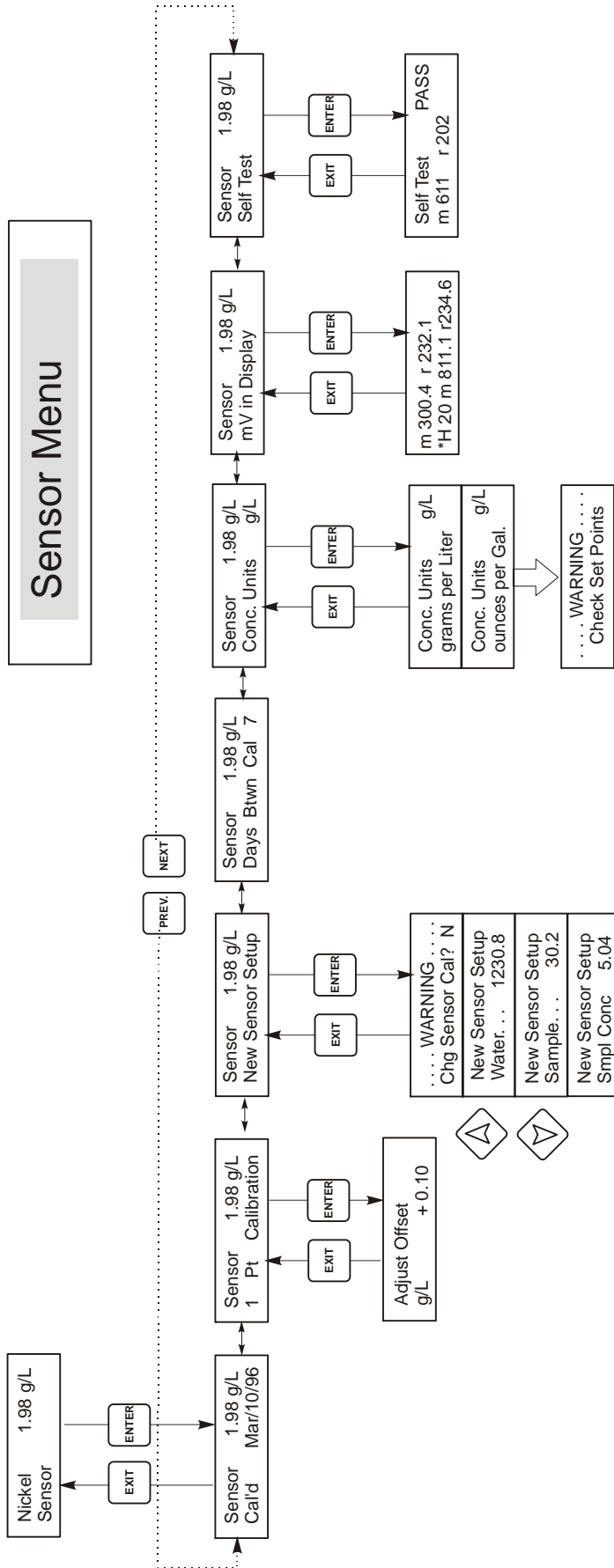

Operation

Press Enter key to enter menu.

Press Exit key to exit menu.

Blinking fields may be edited with the adjust arrows.

Press Enter when modification is complete to return to Main Menu Level.

Figure 8 Sensor Menu

5.3 pH Input Menu

(Only appears if pH option board is installed – in WNI411 models)

The pH input menu provides the following: 1-Point Calibration, 2-Point Calibration, pH millivolts and Self Test. Each is discussed in detail below. Refer to the pH Input Menu chart.

Cal'd	Displays the date of the last electrode calibration.
2 Pt Calibration	If using manual temperature compensation, the first display will be:
	<p>Cal Temp °F/C 68</p> <p>Use the arrow keys to enter the actual temperature of the buffer solutions. If using automatic temperature compensation, this display will not appear. Press ENTER to continue.</p>
	<p>Rinse Electrode</p> <p>Remove the electrode from the process and rinse it off. Press ENTER to go to the next step.</p>
	<p>First Buffer</p> <p>This is a prompt to place the electrode in the first buffer. In a few seconds the controller will automatically go to the next step.</p>
	<p>1st Buffer 7.00</p> <p>The bottom line will display "1st Buffer" on the left hand side and "7.00" on the right hand side. Use the arrow keys to set the pH value of the 1st buffer, then press ENTER. The top line will now show the temperature and the mV input from the electrode. The mV will blink until the value is stable. The controller will automatically go onto the next step or you may press ENTER to go to the next step.</p>
	<p>Rinse Electrode</p> <p>Remove the electrode from the buffer and rinse it off. Press ENTER to go to the next step.</p>
	<p>Second Buffer</p> <p>This is a prompt to place the electrode in the second buffer. Again, in a few seconds the controller will automatically go to the next step.</p>
	<p>2nd Buffer 4.00</p> <p>The bottom line will display "2nd Buffer" on the left hand side and "4.00" on the right hand side. Use the arrow keys to set the pH value of the 2nd buffer, then press ENTER. The top line will now show the temperature and the mV input from the electrode. The mV will blink until the value is stable. The controller will automatically go onto the next step or you may press ENTER to go to the next step.</p> <p>The controller will go on to the next step once the mV signal is stable.</p>
	<p>Cal Successful/Cal Failed</p> <p>If the electrode response is good, then the display will read "Cal Successful". If the mV output of the electrode did not change enough between the two buffer solutions, it will read "Cal Failed". A failure usually means that the electrode needs to be cleaned, or replaced. It will also display the % difference from theoretical slope. A failure occurs if the slope is more than 80% different than theoretical.</p>
	<p>Continue Y</p> <p>The controller will hold this display until you replace the electrode in the process and press ENTER. Control will not begin until ENTER is pressed or 10 minutes go by.</p>
1 Pt Calibration	<p>This calibration procedure assumes that the sensor is installed in the sample loop and a one point process calibration will be done to match the reading of a laboratory meter. Press ENTER to begin the calibration.</p>
	<p>Adjust Offset</p> <p>Adjust the desired offset value using the left/right and up/down arrow keys and pressing ENTER. Be sure to change the plus/minus sign for adjustment in the appropriate direction.</p> <p>For example, if an independent laboratory measurement has indicated that the pH displayed by the WNI controller is 0.1 pH units low, a plus 0.1 pH unit offset would be entered.</p> <p>The maximum adjustment range is ± 0.99 pH units. If more adjustment is needed, it is a sign that the electrode has aged and a two point calibration should be performed. If the electrode fails the 2 point calibration, it should be replaced.</p> <p><i>Remember, a two point calibration will always be more accurate than a one point calibration.</i></p>

Days Btwn Cal	Use the arrow keys to set the number of days that you would like to go by before recalibrating the electrode. The controller will prompt you to recalibrate when that time has expired. Setting the number of days to zero will disable this feature.
Sensor mV	This menu displays the mV from the electrode. It is useful for troubleshooting.
Self Test	Press ENTER to perform a self-test. If it says "FAIL" in the upper right hand corner, this indicates a problem with the controller which should be returned for repair. If it passes, and you have a problem calibrating, it is an electrode or preamp problem.

pH Input Menu

This menu is only available in the WNi411 model.

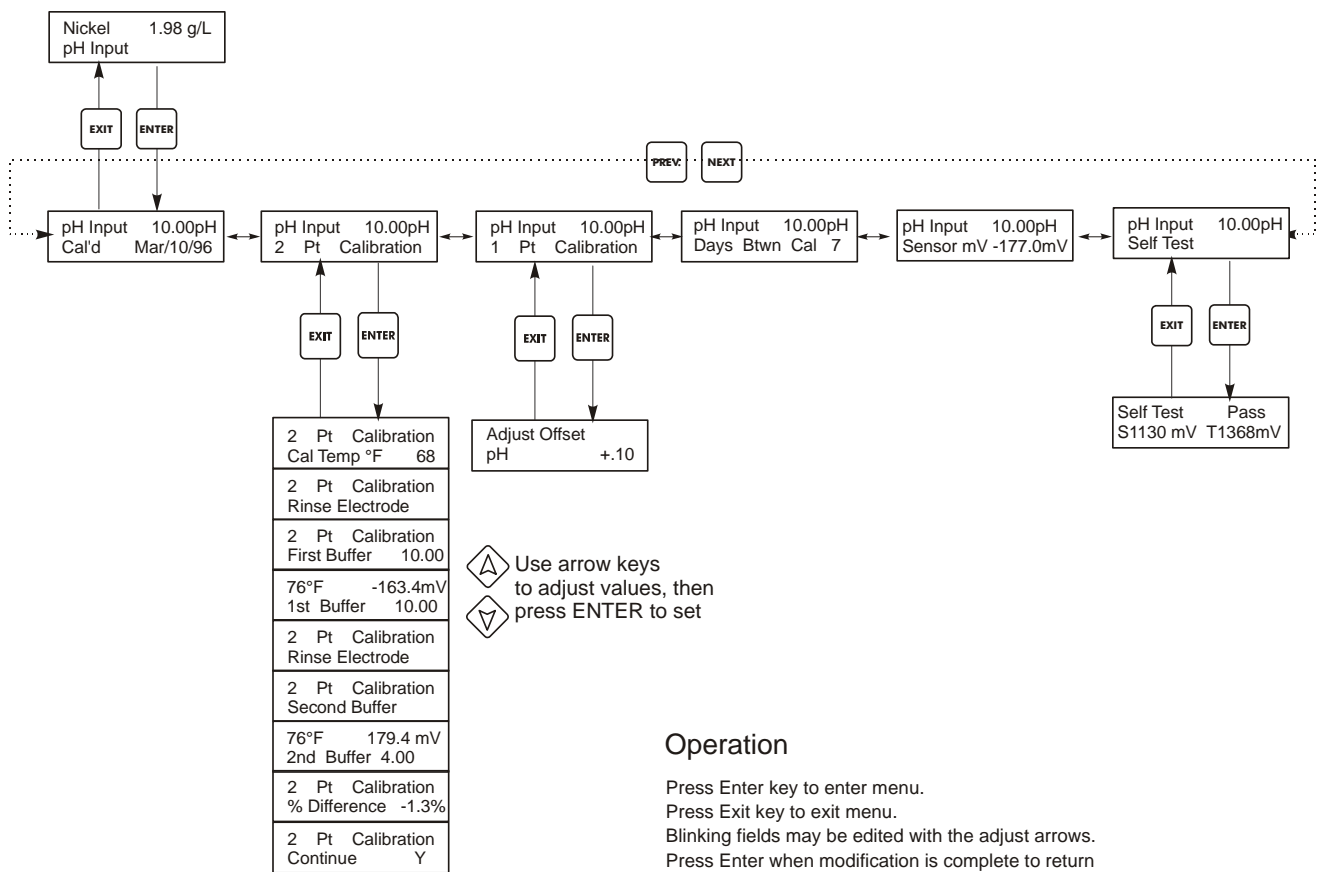

Operation

Press Enter key to enter menu.
 Press Exit key to exit menu.
 Blinking fields may be edited with the adjust arrows.
 Press Enter when modification is complete to return to Main Menu Level.

Figure 9 pH Input Menu

5.4 Temperature Menu

(Only appears if pH option board is installed – in WNI411 models)

The temperature menu contains the following settings: Calibrate and Units (if the Pt100 or Pt1000 sensor is detected when the unit is powered on) or Manual Temp and Units (if no Pt100 or Pt1000 sensor is detected at power-up). Refer to the Temperature Menu chart below.

Calibrate	To Calibrate the Temperature, use a thermometer to measure the fluid temperature and adjust the WPH controller to match. Once Calibrate is entered, the unit continuously displays temperature readings. Press the Up or Down arrow key to change the value displayed to match the thermometer. You must press ENTER to activate the new calibration. You must press the EXIT key to exit calibration.
Man Temp	This menu appears only if no temperature element is connected at power-up. Use the arrow keys to adjust the temperature displayed to match that of the water.
Units	You may choose to display temperature in °C or °F. Press ENTER and the Up or Down Arrow keys to change the temperature units for display.

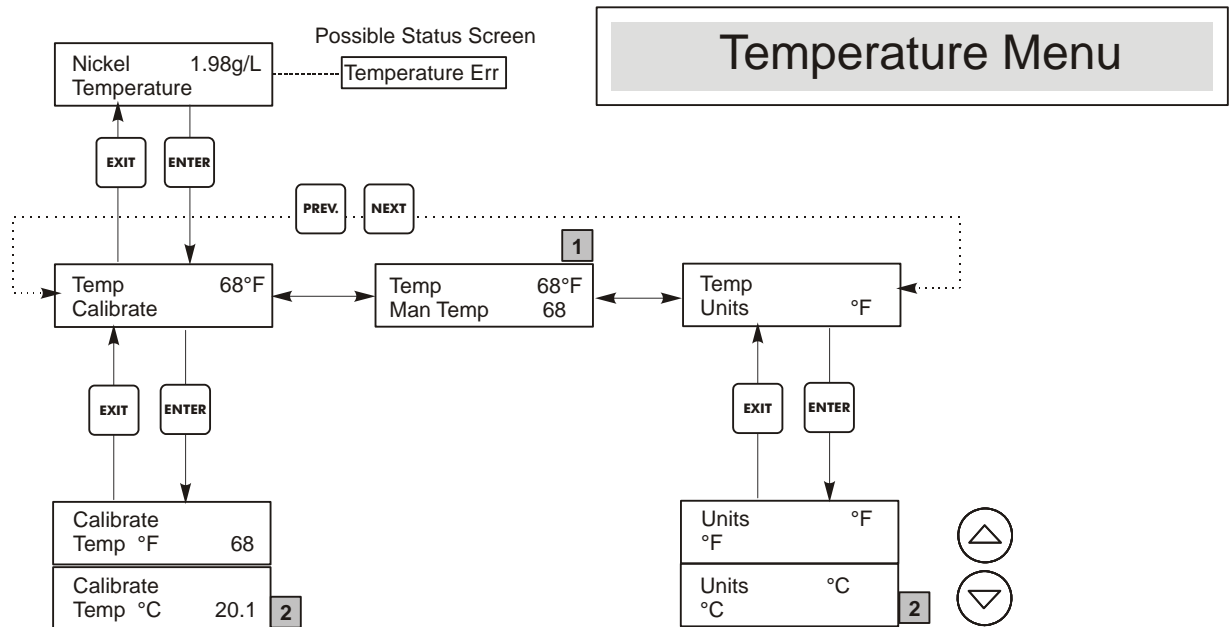

Legend

- 1 Menu wording that appears when Manual Temperature Compensation is selected.
- 2 Menu wording that appears when °C units are selected.

Figure 10 Temperature Menu

5.5 Output 1 Menu

The Output 1 menu is for nickel control and provides the following independent settings: Set Point, Dead Band, Time Limit, Interlock, Total, Output Mode, HOA. The Control menu will be indicated on the display by one of the following:

Out 1 A	OFF	Indicates that the output is currently OFF.
Out 1 A	10:00	Indicates the length of time that the output has been ON.
Out 1 A	Intrlck	Indicates that control has been suspended because the Interlock switch is Open
Out 1 A	TIMEOUT	Indicates that the output has been on longer than the Time Limit.

(The 'A' indicates that the output is being controlled automatically. An "O" indicates the output is in Off mode. An "H" indicates the relay is in Hand mode.)

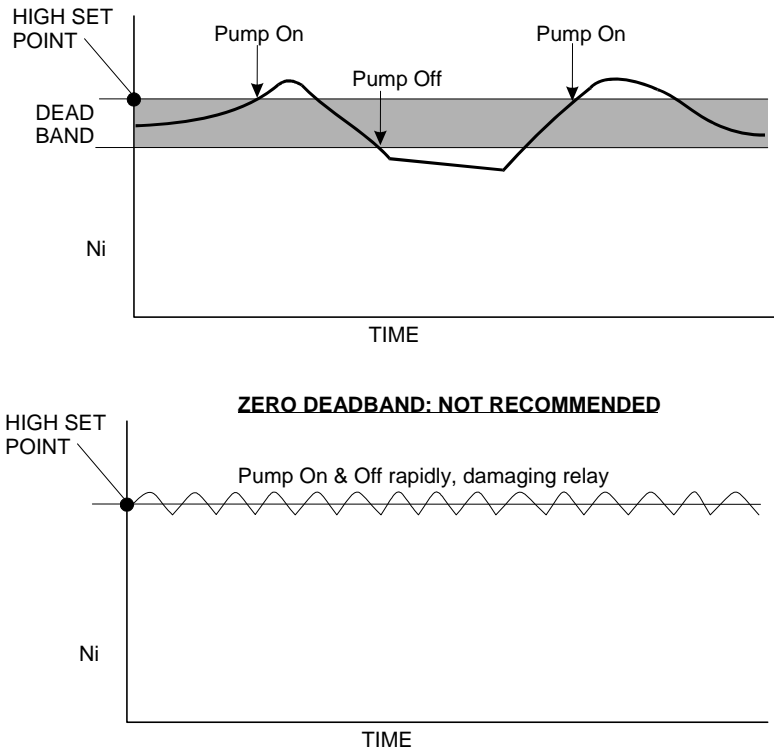
<p>Set Point</p>	<p>Use the arrow keys to adjust the display to read the desired set point value of the bath. Press ENTER to accept the change.</p>
<p>Dead Band</p>	<p>Use the arrow keys to set the desired dead band, then press ENTER. For Microetch Mode, for example, If the set point is 50.00 g/l, and the dead band is 0.5 g/l, then the relay will close at 50 g/l and open 0.5 g/l away from 50 (49.5 g/l).</p> 

Time Limit	Use the arrow keys to set the time limit (min:sec) for the output to be active, then press ENTER . If it is set for "0:00", no limit will be imposed, and the output could stay on forever.
Reset Timer	This menu only appears if the output mode has been selected as a Low Set Point, or a High Set Point and the time limit has expired. Determine the reason that the output stayed on too long, and once the problem has been solved, press ENTER to reset the timer.
Interlock	Use the Up and Down arrows to toggle between Y(Yes) and N(No). Choosing Y means that the output will deactivate if the device attached to the controller is open. For example, if the sensor is installed in a recirculating pipe line, a flow switch that is closed if flow is sufficient and open if flow is insufficient may be installed in the line, so that if flow past the sensor stops, the controller will not pump in chemicals based on a stagnant sample. Similarly, a level switch may be attached to prevent control of an empty batch tank.
Total 1	Press ENTER to program the timer/totalizer functions. The totalizer function allows you to track how much time the output has been on (Total as Time), the volume of chemical that has been added (Total as Vol) or notify you when the bath is ready to be replaced based on the number of metal turnovers (Total as Turns). Total as Vol calculates the volume added by multiplying the relay on-time by the pump flow rate programmed. Total as Turns calculates metal turnovers by multiplying the relay on-time by the pump flow rate, divided by the volume equal to one metal turnover. An alarm is activated when the number of metal turnovers reaches the programmed turnover limit.
	Reset Total Use the arrow keys to toggle between Y(Yes) and N(No) to reset the totalizer.
	Total As Press ENTER , then use the Up and Down arrows to choose whether to totalize in units of time, volume or nickel metal turnovers.
	Turnover Limit Only appears if you choose to totalize by metal turnovers. Use the arrow keys to enter the maximum number of turnovers. The controller will prompt you when this number has been exceeded.
	Turnover Volume Only appears if you choose to totalize by metal turnovers. Enter the number of gallons (G) or liters (L) that equals one metal turnover. The unit of measure displayed correlates with that of the rate units selected in the next menu.
	Rate Units Only appears if you choose to totalize by volume or metal turnovers. Press ENTER , then use the arrow keys to toggle between Gallons per Hour, mL per minute or Liters per hour. These units of measure will be used to enter the rate at which the replenishment pump adds chemicals.
	Pump Rate Only appears if you choose to totalize by volume or metal turnovers. Use the arrow keys to set the flow rate of the replenishment pump.
HOA	Use the Left and Right arrows to move between Hand, Off and Auto. In Hand (Manual) mode, the output will be turned on immediately for a maximum of 10 minutes. In the Off mode, the output will be turned off indefinitely. In the Auto mode, the output turns on and off in response to changes in the process value relative to the set point. The letter inside the block on the status screen indicates which mode the output is in. If power to the controller is lost, it will revert back to Auto mode when power is restored.

Possible Status Screens

Out 1 A	Off
Out 1 A	Intrick
Out 1 A	Timeout
* Out 1 H	9:59

* (If placed in Hand mode, a timer indicates how much time is left before turning off automatically.)

Output 1 Menu

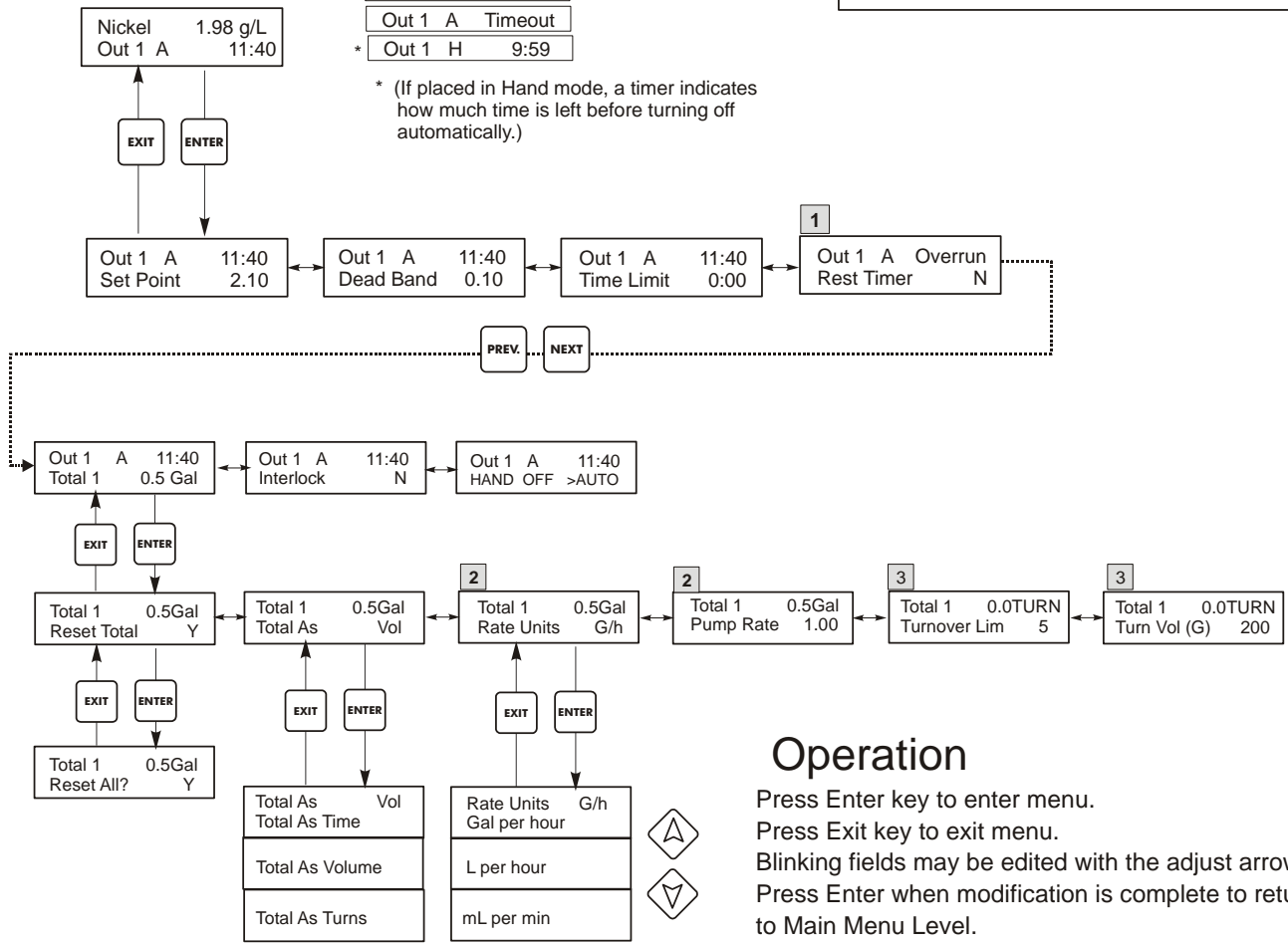

Legend

- 1 Menu appears if a limit timer has expired.
- 2 Menu appears when Total As Volume or Total As Turns is selected
- 3 Menu appears when Total As Turns is selected

Operation

Press Enter key to enter menu.
 Press Exit key to exit menu.
 Blinking fields may be edited with the adjust arrows.
 Press Enter when modification is complete to return to Main Menu Level.

Figure 11 Output 1 Menu

5.6 Output 2 and 3 Menus

The Out 2 and 3 menus are separate from each other but operate in exactly the same way. Each menu provides the Total and H O A settings. These additional outputs are activated simultaneously with Output 1 and are provided to be able to add other bath components in proportion to the nickel, and display independent replenishment totals.

If a pH option board is installed, Output 3 will be replaced by a pH Output menu.

Out 2 A	OFF	Indicates that the output is currently OFF.
Out 2 A	10:00	Indicates the length of time that the output has been ON.
Out 2 A	Intrlck	Indicates that control has been suspended because the Interlock switch is Open
Out 2 A	TIMEOUT	Indicates that the output has been on longer than the Time Limit.

(The 'A' indicates that the output is being controlled automatically. An “O” indicates the output is in Off mode. An “H” indicates the relay is in Hand mode.)

Total 2 or 3	Press ENTER to program the timer/totalizer functions. The totalizer function allows you to track how much time the output has been on (Total as Time), or the volume of chemical that has been added (Total as Vol). Total as Vol calculates the volume added by multiplying the relay on-time by the pump flow rate programmed.
	Reset Total Use the arrow keys to toggle between Y(Yes) and N(No) to reset the totalizer.
	Total As Press ENTER , then use the Up and Down arrows to choose whether to totalize in units of time or volume.
	Rate Units Only appears if you choose to totalize by volume. Press ENTER , then use the arrow keys to toggle between Gallons per Hour, mL per minute or Liters per hour. These units of measure will be used to enter the rate at which the replenishment pump adds chemicals.
	Pump Rate Only appears if you choose to totalize by volume. Use the arrow keys to set the flow rate of the replenishment pump.
HOA	Use the Left and Right arrows to move between Hand, Off and Auto. In Hand (Manual) mode, the output will be turned on immediately for a maximum of 10 minutes. In the Off mode, the output will be turned off indefinitely. In the Auto mode, the output turns on and off in response to changes in the process value relative to the set point. The letter inside the block on the status screen indicates which mode the output is in. If power to the controller is lost, it will revert back to Auto mode when power is restored.

Possible Status Screens

Out 2	A	Off
Out 2	A	Intrck
Out 2	A	Timeout
* Out 2	H	9:59

Output 2 & 3 Menu

* (If placed in Hand mode, a timer indicates how much time is left before turning off automatically.)

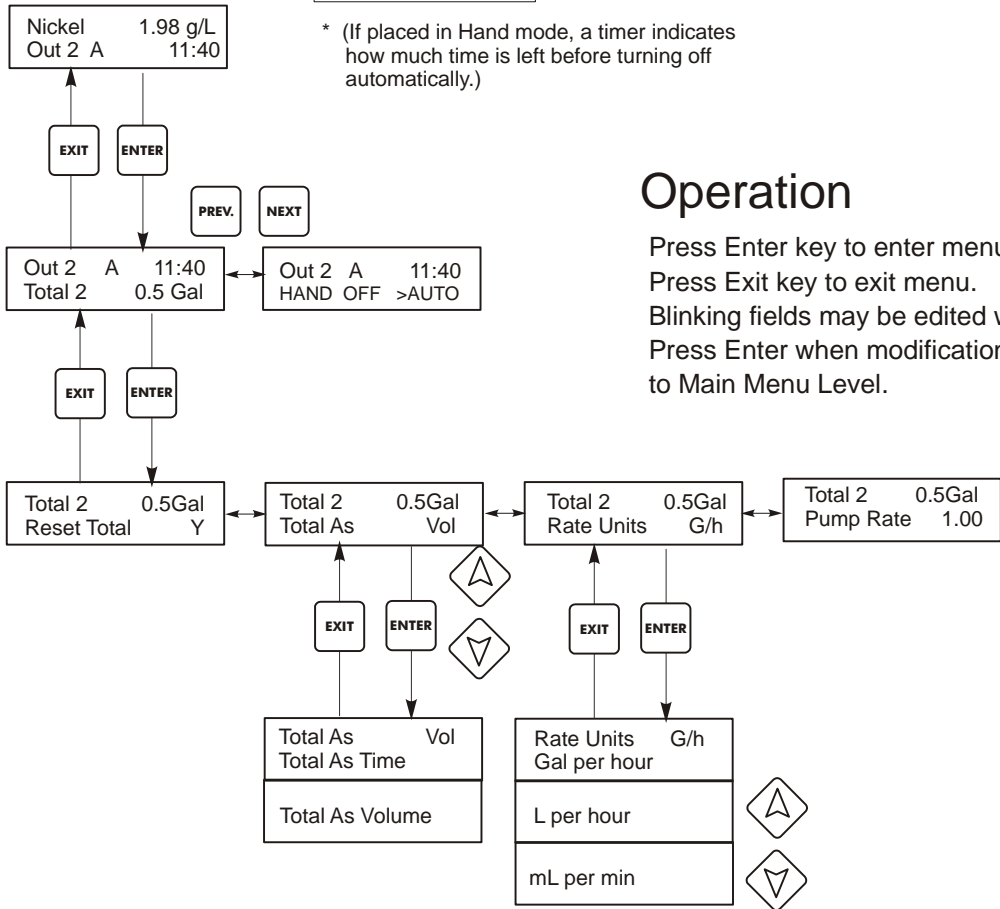

Operation

Press Enter key to enter menu.

Press Exit key to exit menu.

Blinking fields may be edited with the adjust arrows.

Press Enter when modification is complete to return to Main Menu Level.

Figure 12 Output 2 and 3 Menu

5.7 pH Output (Output 3) Menu

(Only appears if the pH option circuit board is installed – in WNI411 models)

This menu is used to set the pH output set points. This menu provides the following settings: Set Point, Dead Band, Time Limit, Mode, Interlock, Total and HOA.

pH Out A	OFF	Indicates that the output is currently OFF.
pH Out A	10:00	Indicates the length of time that the output has been ON.
pH Out A	Intrlck	Indicates that control has been suspended because the Interlock switch is Open
pH Out A	TIMEOUT	Indicates that the output has been on longer than the Time Limit.

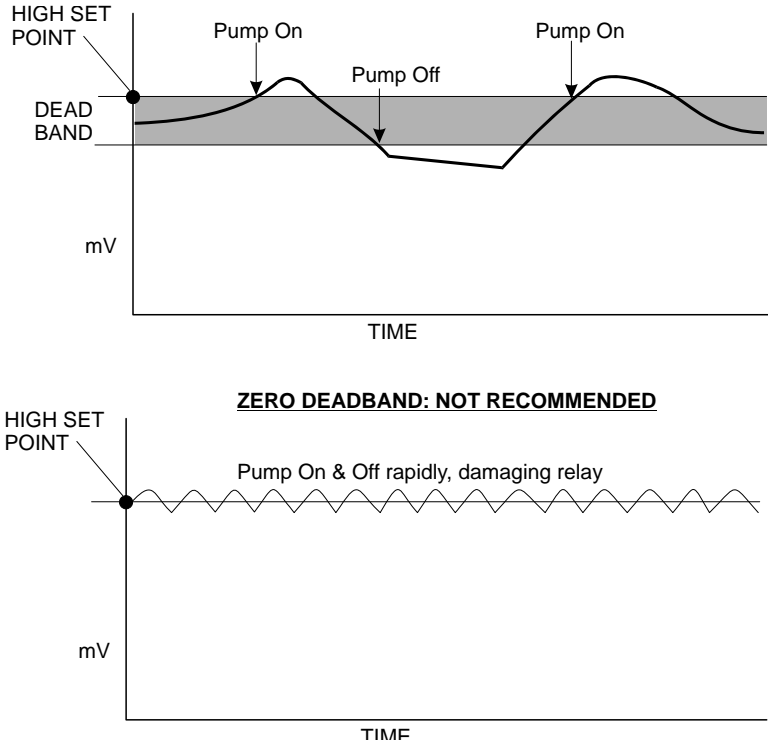
<p>Low Set Point</p>	<p>Only appears if the Mode is Low Set Point or Time Prop Lo Press ENTER if you want the Control relay to close if the process goes below a certain value. The status screen message will be Output ON. This denotes a normal correction of the process value. If you want the status message to be Low Alarm, indicating a problem, choose an Output Mode of Low Alarm as described below.</p>
<p>High Set Point</p>	<p>Only appears if the Mode is High Set Point or Time Prop Hi Press ENTER if you want the Control relay to close if the process above a certain value. The status screen message will be Output ON. This denotes a normal correction of the process value. If you want the status message to be High Alarm, indicating a problem, choose an Output Mode of High Alarm as described below.</p>
<p>Dead Band</p>	<p>Use the arrow keys to set the desired dead band, then press ENTER. If the set point is pH 7.00, and the dead band is 0.05 pH units, then the relay will close at pH 7.00 and open 0.05 pH units away from 7.00.</p>  <p>ZERO DEADBAND: NOT RECOMMENDED</p>
<p>Time Limit</p>	<p>This menu only appears if the output mode has been selected as a Low Set Point, or a High Set Point. Use the arrow keys to set the time limit (min:sec) for the output to be active, then press ENTER. If it is set for "0:00", no limit will be imposed, and the output could stay on forever.</p>

Reset Timer	<p>This menu only appears if the output mode has been selected as a Low Set Point, or a High Set Point and the time limit has expired.</p> <p>Determine the reason that the output stayed on too long, and once the problem has been solved, press ENTER to reset the timer.</p>
Mode	<p>Press the ENTER key to change the mode in which the output will operate. The relays may be a low set point or a high set point. Use the arrow keys to scroll through the choices.</p>
	<p>Low Set Point</p> <p>Press ENTER when this is displayed to select a low set point. The relay will close when the process value goes below the set point value. The summary screen will display that the output is on. A time limit menu will be available, to prevent runaway control. An Interlock menu will be available to allow you to stop control.</p>
	<p>High Set Point</p> <p>Press ENTER when this is displayed to select a high set point. The relay will close when the process value goes above the set point value. The summary screen will display that the output is on. A time limit menu will be available, to prevent runaway control. An Interlock menu will be available to allow you to stop control.</p>
Interlock	<p>Use the Up and Down arrows to toggle between Y(Yes) and N(No). Choosing Y means that the output will deactivate if the device attached to the controller is open. For example, if the electrode is installed in a recirculating pipe line, a flow switch that is closed if flow is sufficient and open if flow is insufficient may be installed in the line, so that if flow past the electrode stops, the controller will not pump in chemicals based on a stagnant sample. Similarly, a level switch may be attached to prevent control of an empty batch tank.</p>
Total 3	<p>Press ENTER to program the timer/totalizer functions. The totalizer function allows you to track how much time the output has been on (Total as Time), or the volume of chemical that has been added (Total as Vol). Total as Vol calculates the volume added by multiplying the relay on-time by the pump flow rate programmed.</p>
	<p>Reset Total</p> <p>Use the arrow keys to toggle between Y(Yes) and N(No) to reset the totalizer.</p>
	<p>Total As</p> <p>Press ENTER, then use the Up and Down arrows to choose whether to totalize in units of time or volume.</p>
	<p>Rate Units</p> <p>Only appears if you choose to totalize by volume. Press ENTER, then use the arrow keys to toggle between Gallons per Hour, mL per minute or Liters per hour. These units of measure will be used to enter the rate at which the replenishment pump adds chemicals.</p>
	<p>Pump Rate</p> <p>Only appears if you choose to totalize by volume. Use the arrow keys to set the flow rate of the replenishment pump.</p>
HOA	<p>Use the Left and Right arrows to move between Hand, Off and Auto. In Hand (Manual) mode, the output will be turned on immediately for a maximum of 10 minutes. In the Off mode, the output will be turned off indefinitely. In the Auto mode, the output turns on and off in response to changes in the process value relative to the set point. The letter inside the block on the status screen indicates which mode the output is in.</p> <p>If power to the controller is lost, it will revert back to Auto mode when power is restored.</p>

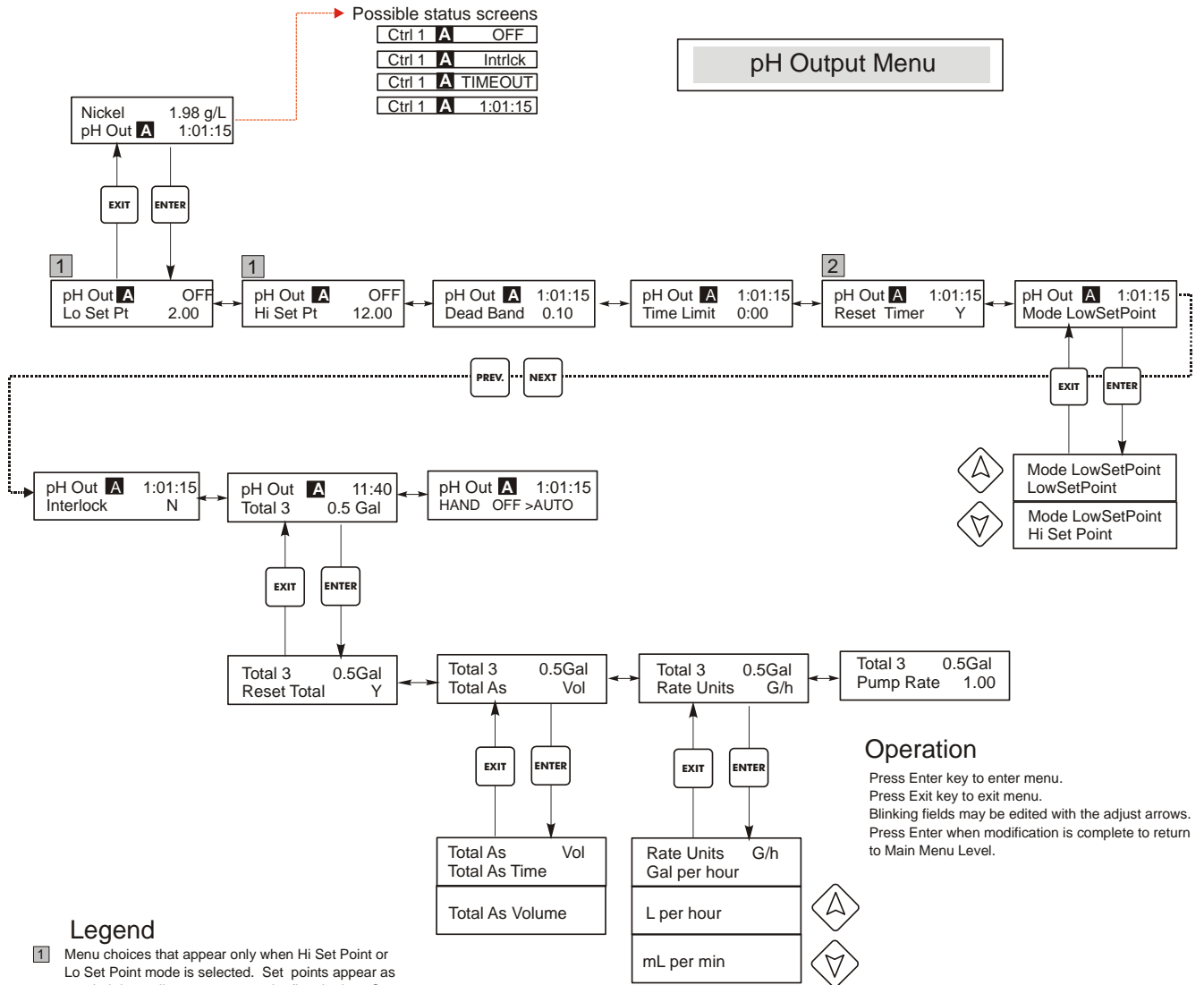

Figure 13 pH Output Menu

5.8 Output 4 and Alarm Menus

Output 4 can be selected to function the same as Outputs 2 and 3, activating at the same time as Output 1, or it may be selected as a programmable alarm relay. The Alarm output (relay 6) will activate in response to any diagnostic alarm plus it can also be selected as a programmable alarm relay.

The Output 4 and Alarm menus provide the following independent settings: Set Points, Dead Band, Time Limit, Interlock, Output Mode, and HOA. The Output menu will be indicated on the display by one of the following:

NOTE: When programming the unit for the first time, go to the “Mode” menu to select how that output will operate. Making this assignment first will bring up the correct menus for the Mode you are using.

Out 4 A	OFF	Indicates that the output is currently OFF.
Out 4 A	10:00	Indicates the length of time that the output has been ON.
Out 4 A	Intrlck	Indicates that control has been suspended because the Interlock switch is Open
Out 4 A	TIMEOUT	Indicates that the output has been on longer than the Time Limit.

(The 'A' indicates that the output is being controlled automatically. An “O” indicates the output is in Off mode. An “H” indicates the relay is in Hand mode.)

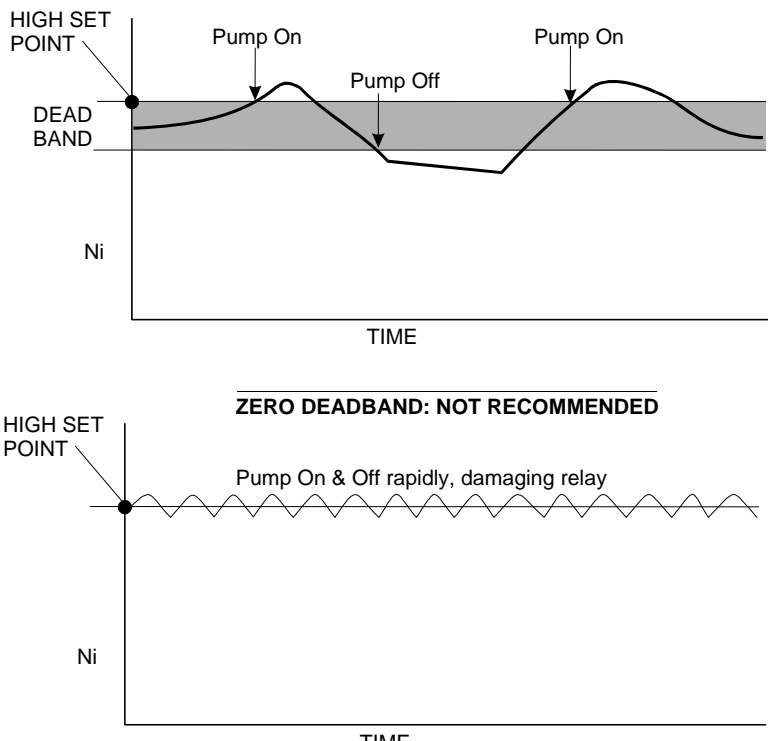
<p>Low Alarm</p>	<p>Only appears if the Mode is Low Alarm, In Range or Out of Range</p> <p>Press ENTER if you want the Control relay to close if the process goes below a certain value. The status screen message will be Output ON. This denotes a normal correction of the process value. If you want the status message to be Low Alarm, indicating a problem, choose an Output Mode of Low Alarm as described below.</p>
<p>High Alarm</p>	<p>Only appears if the Mode is High Alarm, In Range or Out of Range</p> <p>Press ENTER if you want the Control relay to close if the process above a certain value. The status screen message will be Output ON. This denotes a normal correction of the process value. If you want the status message to be High Alarm, indicating a problem, choose an Output Mode of High Alarm as described below.</p>
<p>Dead Band</p>	<p>Use the arrow keys to set the desired dead band, then press ENTER. For Microetch Mode, for example, If the set point is 50.00 g/l, and the dead band is 0.5 g/l, then the relay will close at 50 g/l and open 0.5 g/l away from 50 (49.5 g/l).</p>  <p>The figure contains two graphs. The top graph shows a process value N_i on the y-axis and TIME on the x-axis. A horizontal line represents the HIGH SET POINT. A shaded region below it represents the DEAD BAND. The process value fluctuates around the set point. When it rises above the dead band, the pump turns on. When it falls below the dead band, the pump turns off. The bottom graph is titled "ZERO DEADBAND: NOT RECOMMENDED". It shows the same process value N_i and set point, but with no dead band. The process value fluctuates rapidly around the set point, causing the pump to turn on and off frequently, which is labeled as "Pump On & Off rapidly, damaging relay".</p>

Time Limit	This menu only appears if the output mode has been selected as a Low Set Point, or a High Set Point. Use the arrow keys to set the time limit (min:sec) for the output to be active, then press ENTER . If it is set for "0:00", no limit will be imposed, and the output could stay on forever.
Reset Timer	This menu only appears if the output mode has been selected as a Low Set Point, or a High Set Point and the time limit has expired. Determine the reason that the output stayed on too long, and once the problem has been solved, press ENTER to reset the timer.
Mode	Press the ENTER key to change the mode in which the output will operate. The relays may be a low set point, a high set point, a low alarm, a high alarm, an out-of-range alarm, an in-range output, or for Output 4 a Follow Out 1 mode. Use the arrow keys to scroll through the choices.
	Low Alarm Press ENTER when this is displayed to select a low alarm. The relay will close when the process value goes below the set point value. The summary screen will display "Low Alarm". No time limit or interlock features will be available.
	High Alarm Press ENTER when this is displayed to select a high alarm. The relay will close when the process value goes above the set point value. The summary screen will display "High Alarm". No time limit or interlock features will be available.
	Out Range Alarm Press ENTER when this is displayed to select an out-of-range alarm. The relay will close when the process value is either above or below the two set point values. The summary screen will display "Range Alarm". No time limit or interlock features will be available.
	In Range Output Press ENTER when this is displayed to select an in-range output. The relay will close when the process value is between the two set point values. The summary screen will display "In Range Output". No time limit or interlock features will be available.
	Follow Out 1 Press ENTER when this is displayed to select Output 4 to activate at the same time as Output 1, to feed a chemical in proportion to the nickel.
Interlock	Use the Up and Down arrows to toggle between Y(Yes) and N(No). Choosing Y means that the output will deactivate if the device attached to the controller is open. For example, if the sensor is installed in a recirculating pipe line, a flow switch that is closed if flow is sufficient and open if flow is insufficient may be installed in the line, so that if flow past the sensor stops, the controller will not pump in chemicals based on a stagnant sample. Similarly, a level switch may be attached to prevent control of an empty batch tank.
Total 4	Only appears if Output 4 is in Follow Out 1 Mode. Press ENTER to program the timer/totalizer functions. The totalizer function allows you to track how much time the output has been on (Total as Time), or the volume of chemical that has been added (Total as Vol). Total as Vol calculates the volume added by multiplying the relay on-time by the pump flow rate programmed.
	Reset Total Use the arrow keys to toggle between Y(Yes) and N(No) to reset the totalizer.
	Total As Press ENTER , then use the Up and Down arrows to choose whether to totalize in units of time or volume.
	Rate Units Only appears if you choose to totalize by volume. Press ENTER , then use the arrow keys to toggle between Gallons per Hour, mL per minute or Liters per hour. These units of measure will be used to enter the rate at which the replenishment pump adds chemicals.
	Pump Rate Only appears if you choose to totalize by volume. Use the arrow keys to set the flow rate of the replenishment pump.
HOA	Use the Left and Right arrows to move between Hand, Off and Auto. In Hand (Manual) mode, the output will be turned on immediately for a maximum of 10 minutes. In the Off mode, the output will be turned off indefinitely. In the Auto mode, the output turns on and off in response to changes in the process value relative to the set point. The letter inside the block on the status screen indicates which mode the output is in.

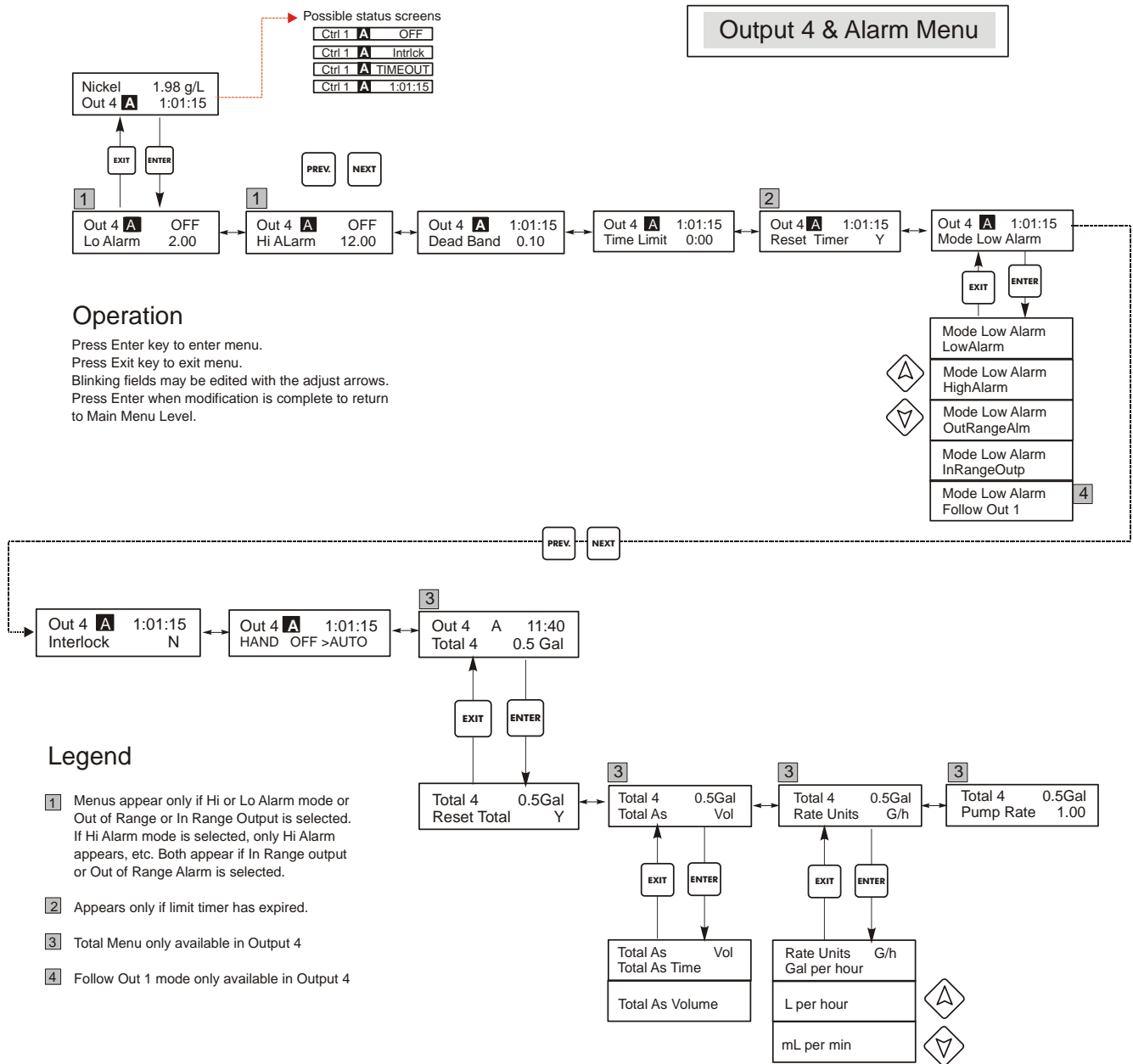

Figure 14 Output 4 and Alarm menu

5.9 4-20 mA 1 and 2 Menus (Optional)

These menus will only appear if the optional 4-20 mA output board(s) is installed. They are used to set the scale of the 4-20 mA output. It contains the following menu selections: Assign Inputs, 4 mA Point, 20 mA Point, and Calibrate.

Assign Inputs	Only available if the pH option board is installed – in WNI411 models. Press ENTER to assign the 4-20 mA output to a sensor input. Use the arrow keys to toggle between “pH” and “Nickel.” Press ENTER when the desired choice is displayed.
4 mA Pt	Use the arrow keys to enter the process value (in the units selected in the Sensor menu) that you want to correspond to a 4 mA output from the controller.
20 mA Pt	Use the arrow keys to enter the process value that you want to correspond to a 20 mA output from the controller.
Calibrate	This menu is used to calibrate instruments connected to the mA output. The 4-20 mA output is extremely accurate and stable and therefore will never need calibration. This feature allows other devices to be calibrated at the 4 and 20 mA points. Press ENTER to start the calibration.
Fixed 4 mA Out	The controller will output 4.00 mA. Adjust the chart recorder or data logger per its instruction so that the process value displayed is what is expected for a 4.00 mA input.
Fixed 20 mA Out	As above, except that the controller will output 20.00 mA. The design of the 4-20 mA output is such that it should never need calibration. If the mA signal is not what it should be, call the factory for service.

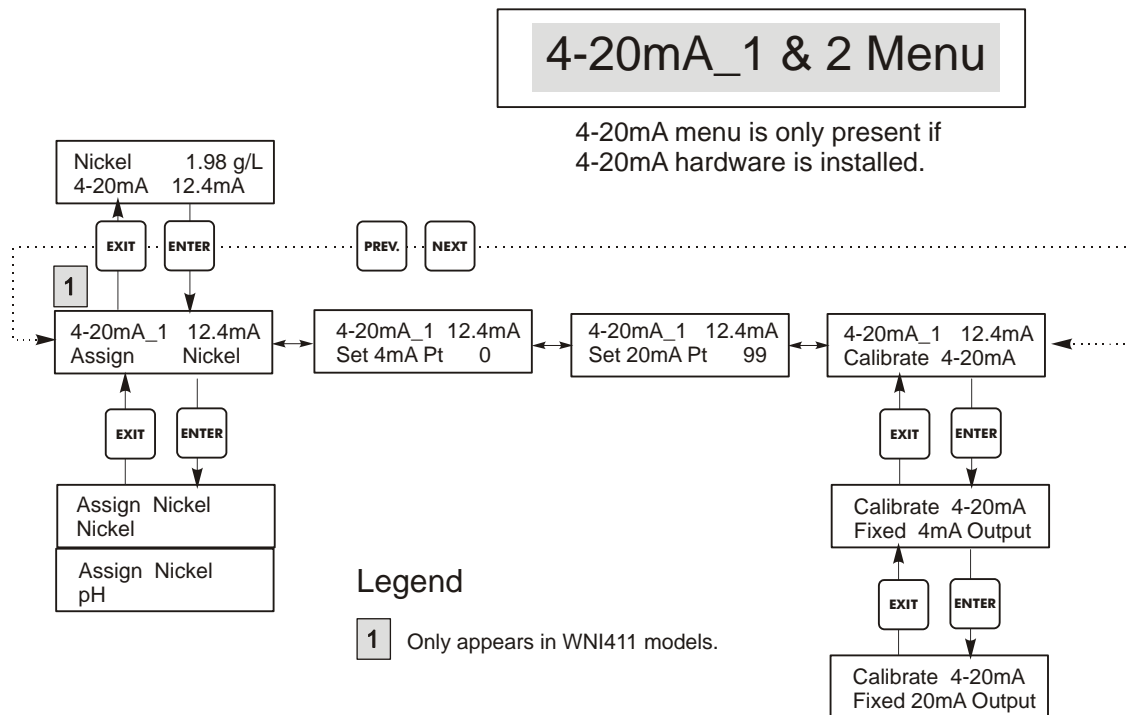

Figure 15 4-20 mA 1 and 2 Menus

5.10 Time Menu

The time menu is used to set the date and time that the controller uses to schedule probe washing and calibration prompts. There is only one menu selection: Set Clock.

Set Clock	Press ENTER to set the clock. Use the arrow keys to change the year, date, and month, then press ENTER . Use the arrow keys again to set the day of the week and the time. Use military time (for example, 1:00 PM is 13:00). Press ENTER to return to the top level clock menu.
-----------	---

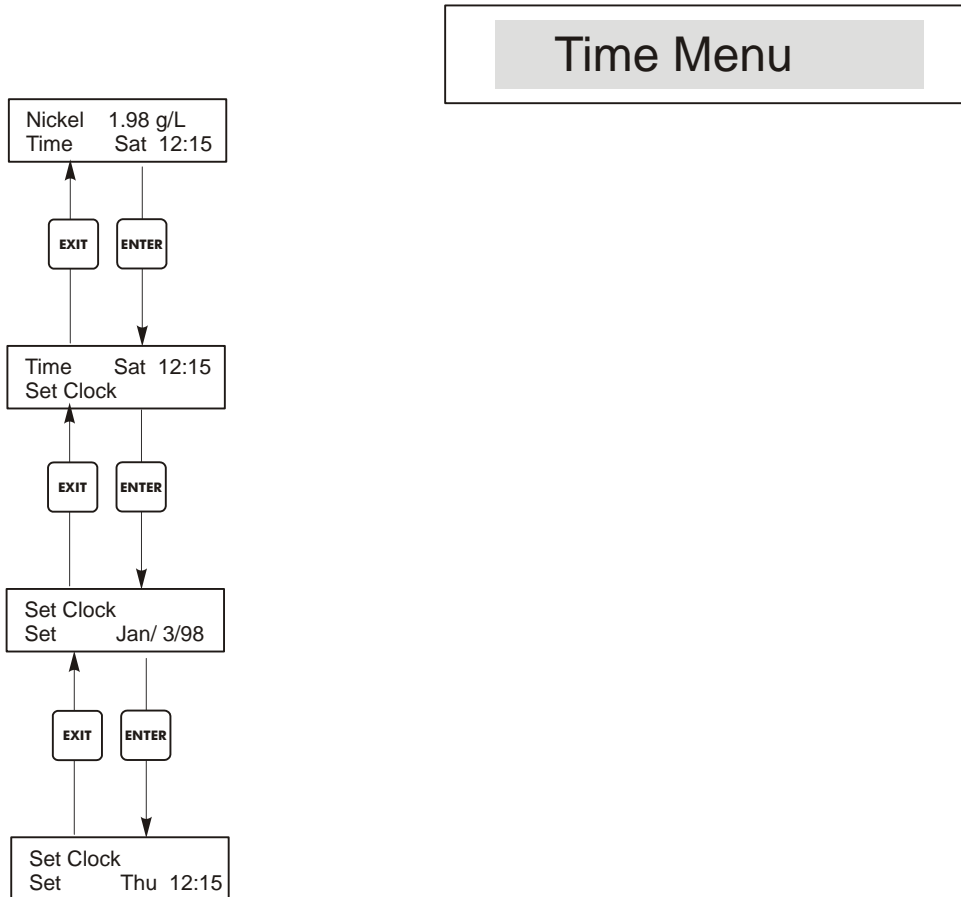

Figure 16 Time Menu

5.11 Access Code Menu

This menu determines whether the access code feature of the controller is enabled or disabled and allows you to customize the access code to your own value. The access code controls whether or not you are allowed to change the parameters in the controller. With the access code disabled, any user may change any parameter. With the access code enabled, any user can view any parameter, but cannot change them. Once an attempt is made to change a parameter, the display will prompt the user to enter the access code. If the correct access code is entered, the parameters can be changed. If the wrong access code is entered the parameters cannot be changed. Once the access code has been correctly entered, it will remain valid until there is a period of 10 minutes without a key being pressed. The access code menu will appear as shown below:

Access Code	DIS	Indicates that the access code is disabled. No access code is required to change any setting.
Access Code	REQ	Indicates that the access code is required to alter settings.
Access Code	OK	Indicates that the access code is required and has been entered correctly.

Enable N / Y	Press the Up or Down arrow key to change the N to Y and press ENTER to enable the access code feature. If the access code is enabled you must first enter the access code to disable it.
New Value	<p>Press ENTER to display the current access code value and use the arrow keys to change it to any value between 0 and 9999. If the access code has been enabled, you will be prompted to enter the current access code before being allowed to change it. You must remember the access code if you enable it.</p> <p>The Factory default Access code is 1995.</p> <p>If you change the access code and can't remember it follow this procedure:</p> <ol style="list-style-type: none"> 1. Turn off power to the controller. 2. Wait 10 seconds. 3. Press and Hold the UP and DOWN arrow keys while turning on the power. 4. Read the access code on the display. 5. Release the keys, and the access code will disappear.

Access Code Menu

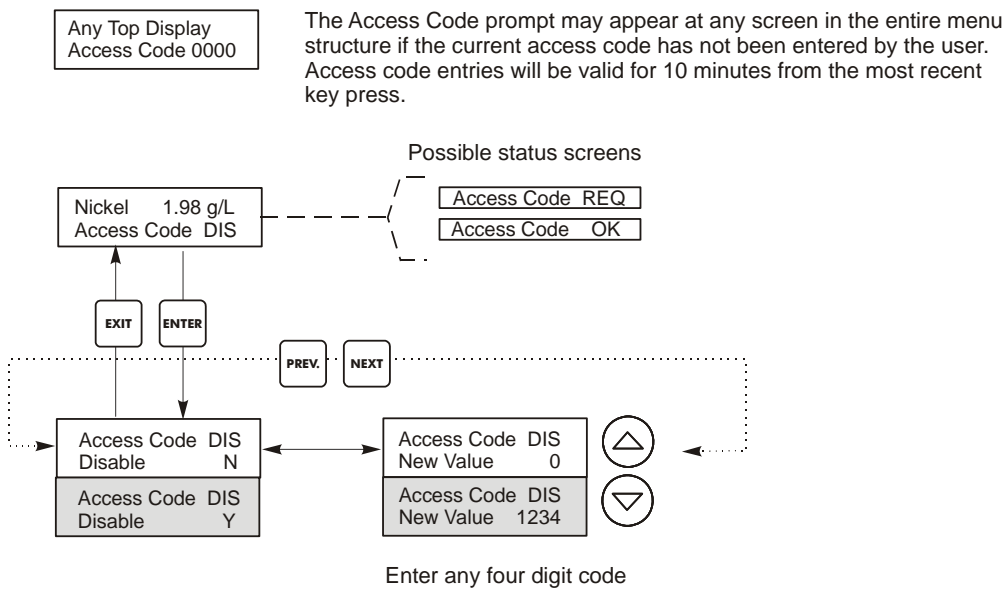

Figure 17 Access Code Menu

5.12 Datalog Menu

This menu is available if the data logging option has been purchased. This is indicated in the model code by the letter U at the end of the model code. This menu allows you to save data from the controller to a USB flash drive.

The controller has four logs, the Current Datalog, the Backup Datalog, the Event Log, and the Reset Log. All files are in a CSV format that may be opened in a spreadsheet such as Microsoft Excel.

Current Datalog	<p>Contains the following data taken at 10 minute intervals:</p> <ul style="list-style-type: none"> Nickel concentration Optional pH Optional Temperature <p>When the current datalog is downloaded to a USB stick, it is erased and a new log file is started. If the current datalog is not downloaded before it reaches its maximum size (at least 60 days of data) the oldest data is overwritten by the newest data.</p>	
Backup Datalog	<p>Contains the same data as the current log but it is never erased. When the backup log reaches its maximum size (at least 60 days of data), the oldest data is overwritten by the newest data.</p>	
Event Log	<p>Contains columns for each relay and flow switch input, as well as the date and time. Each time any of these change state, the date and time is updated and it will show a 1 if the relay is on and 0 if it is off, and a 1 if the flow switch indicates no flow, 0 if there is flow. Tens of thousands of events will be recorded before the oldest data is overwritten by the newest, the number varying with the controller's configuration.</p>	
Reset Log	<p>Consists of time stamps of when power was lost, when it was returned, and the cause of the reset.</p>	
Current or Backup Datalog	<p>Place a USB flash drive with at least 10 MB capacity into the USB port on the front panel of the controller. Press the Enter key to download the file from the controller to the disk. The file name for the Current Datalog will be Datalog<serial number><date><time>.csv using the date and time it was downloaded. The file name for the Backup Datalog will be Datalog<serial number><date><time>.csv using the date and time it was created.</p> <p>The controller will display the progress of the file download process. If the file was successfully copied to the USB disk the controller will display Transfer Success.</p>	
Copy Event Log	<p>Place a USB flash drive with at least 10 MB capacity into the USB port on the front panel of the controller. Press the Enter key to download the file from the controller to the stick. The file name will be Eventlog<serial number><date><time>.csv.</p> <p>The controller will display the progress of the file download process. If the file was successfully copied to the USB disk the controller will display Transfer Success, otherwise Transfer Fail 1.</p>	
	Transfer Success	Transfer Fail 1
Copy Reset Log	<p>Place a USB flash drive with at least 10 MB capacity into the USB port on the front panel of the controller. Press the Enter key to download the file from the controller to the stick. The file name will be Resetlog<serial number><date><time>.csv.</p> <p>The controller will display the progress of the file download process. If the file was successfully copied to the USB disk the controller will display Transfer Success.</p>	
	Transfer Success	Transfer Fail 1

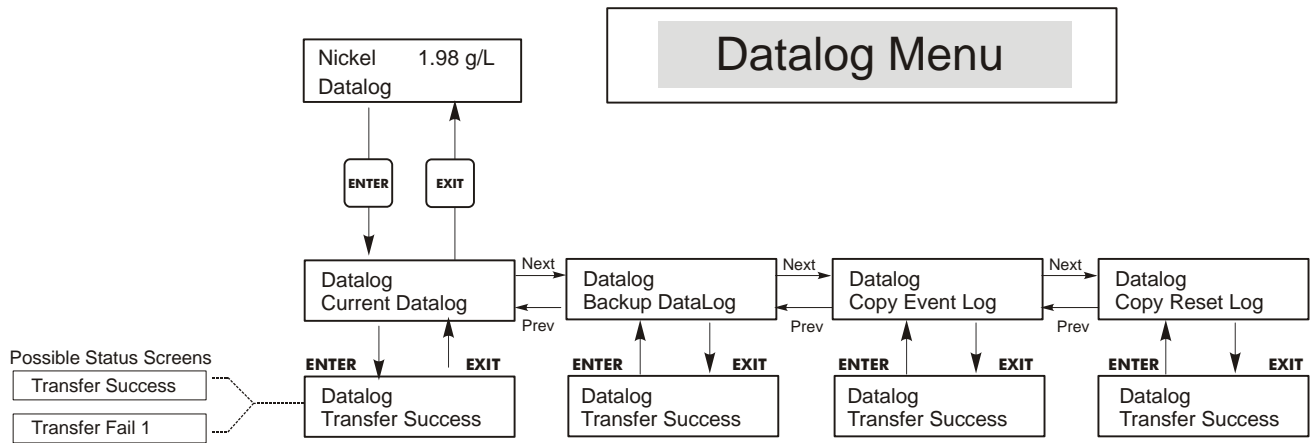

Figure 18 Datalog Menu

5.13 Config Menu

This menu allows you to export a file that contains all of the set points in the controller to a USB flash disk drive, and then later import the set points into another controller.

Export Config	<p>Place a USB flash drive with at least 10 MB capacity into the USB port on the front panel of the controller. Press the Enter key to export the configuration file from the controller to the stick. The file name will be UCF.ini. If you are exporting files with different set points you may rename the file to something that describes it, as long as it has an ini extension.</p> <p>The controller will display the progress of the file download process. If the file was successfully exported to the USB disk the controller will display Transfer Success, otherwise Transfer Fail 1.</p>	
	Transfer Success	Transfer Fail 1
Import Config	<p>Place a USB flash drive that contains only one configuration file stored on the root directory of the stick into the USB port on the front panel of the controller. Press the Enter key to import the configuration file from the stick to the controller. The file name must have an ini extension in its name.</p> <p>The controller will display the progress of the file import process. If the file was successfully imported from the USB disk the controller will display one of the messages below:</p>	
	Import Failure	Indicates that there were problems connecting to or accessing the USB stick.
	Import Success: Any key to reboot	The configuration file import succeeded and will be ready for use after reboot.
	File Open Failed	A config file could not be found on the USB stick or the USB stick file system could not be accessed.
	File Read Failed	The config file is too short (incomplete) or empty.
	Invalid CFG File	The imported file is not a valid config file.
	Invalid Model	The imported config file is not for this controller model.
	Wrong SW Version	The version of the imported config file is not compatible with this controller software version.
	Corrupt CFG File	The imported config file is corrupt. (The checksum failed.)
	Wrong file Size	The size of the imported config file is wrong.

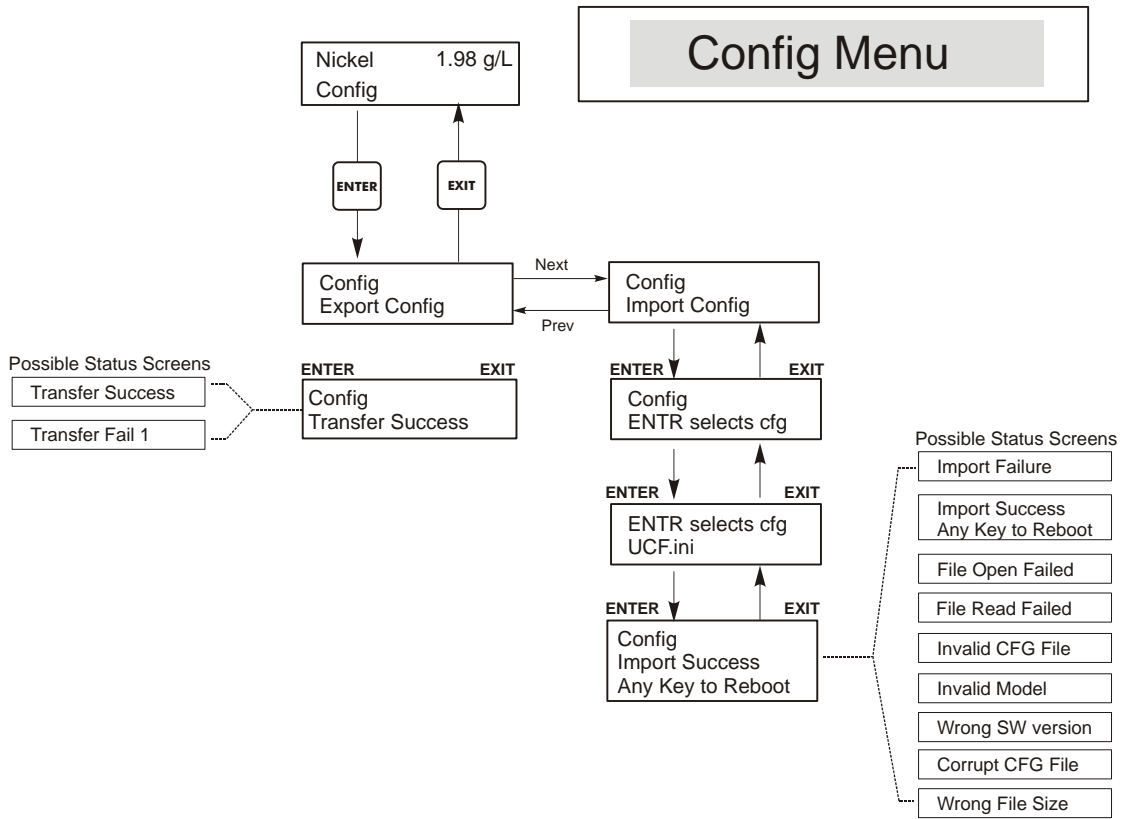

Figure 19 Config Menu

5.14 Upgrade Menu

This menu is used to upgrade the software to a newer version. If a new version of the software is available, an upgrade file will be posted on our web site. Save this file to a USB flash disk drive. It needs to be the only upgrade file stored on the root directory of the stick. Press the Enter key to import the software upgrade file from the stick to the controller.

The controller will display the progress of the file import process. If the file was successfully imported from the USB disk the controller will display Transfer Success. The controller will automatically reboot and come up with the new software installed.

Upgrade	The controller will display the progress of the file import process. If the file was successfully imported from the USB disk the controller will display Transfer Success. The controller will automatically reboot and come up with the new software installed. If the software upgrade fails, you will see one of the following messages:	
	UpgradFileInvald	The file found on the USB stick is for the wrong product, or is corrupt. Try getting the correct upgrade file and make sure it's the only upgrade file on the stick.
	No Upgrade File	There is no upgrade file stored on the stick, or the file is named incorrectly.
	CorrptUpgradFile	Try getting a new copy of the file.
	Flash Failure	The flash memory on the processor board has a problem. Repair or replace the front panel assembly.

To check that it was successful, turn off power to the controller, then press the Enter key while turning power on. The controller will show the software version, which should match the name of the upgrade file that you used.

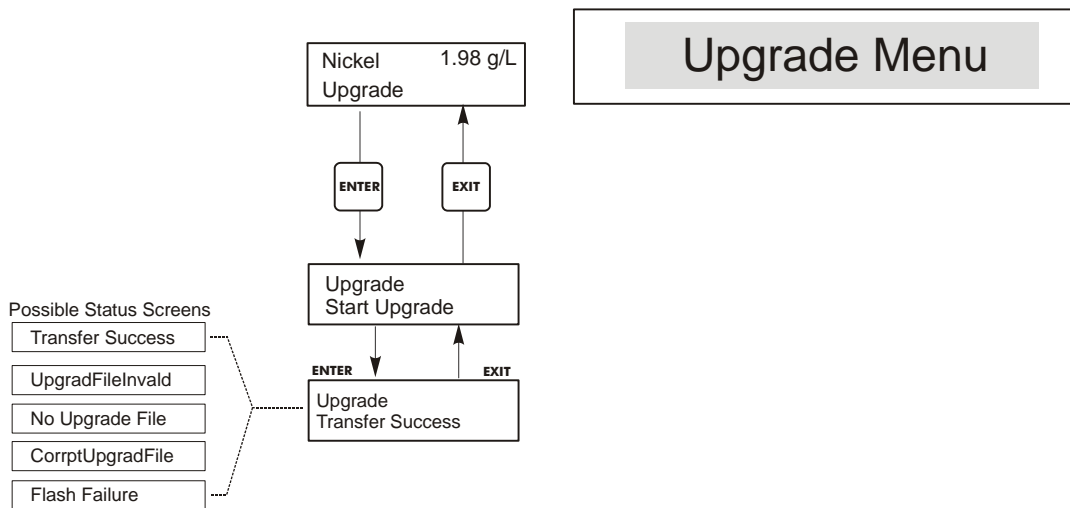

Figure 20 Upgrade Menu

6.0 MAINTENANCE

The WNI control module itself needs very little maintenance. Clean the outside of the controller enclosure with a damp cloth. Do not spray down the controller unless the enclosure door is closed and latched. "Pigtails" should be protected from spray or wash-down. Check the cords and cables for damage.

6.1 Nickel Sensor Cleaning

NOTE: The controller must be recalibrated after cleaning the sensor.

Frequency

The sensor should be cleaned periodically. The frequency required will vary by installation. In a new installation, it is recommended that the sensor be cleaned only if a 1-Point Calibration cannot be successfully performed.

Cleaning Procedure

The most important maintenance item for the sensor is to keep the optical paths clean of plate-out or other coatings. In electroless nickel applications, the sensor should be etched when the tank is etched, or whenever plate-out is evident. If plate-out does occur in the sample line or sensor, etch the system as you would the tank.

Avoid any mechanical cleaning of the optical surfaces to avoid scratching them. Chemical cleaning is preferred over mechanical cleaning methods. Plate-out should be removed using nitric acid or a persulfate or peroxide/sulfuric etch.

6.2 pH Electrode Maintenance

The pH electrode require periodic cleaning and calibration. These electrodes are like batteries and their voltage outputs will change with time even if they are not being used. After installation, the rate of change increases, and factors such as temperature, extremes of pH, abrasion and chemical attack will increase the required frequency of calibration. If the process solution contains oils, scale or other solids, the electrode surfaces will tend to coat, its response time will slow down and cleaning will be required.

The frequency of cleaning and calibrating will vary greatly depending upon the application, the factors listed above, as well as the accuracy of control you require. The best way to determine the optimum number of days between calibrations is to remove the electrode from the process periodically (weekly in clean water applications, daily in dirty or hot applications) and check its accuracy in a buffer solution. If using manual temperature compensation, remember to change the temperature from that of the process to that of the buffer. If the accuracy of the reading is within your required tolerances, and the speed of response is good, replace the electrode in the process. If not, clean the electrode and perform a two point calibration.

The method of cleaning the electrode will depend upon the coating, as well as the materials of construction of the electrode. Do not use a solvent that will attack the electrode! Care must be taken to avoid scratching the pH electrode's glass, as this will shorten its life.

Oily coatings should be removed with a mild detergent or isopropyl alcohol. Hard scales such as calcium carbonate can usually be removed with a dilute hydrochloric acid solution. Soft coatings can be removed using a soft cloth or soft toothbrush.

A two point calibration should always be performed after cleaning the electrode.

Because the electrode signal is so sensitive, the condition of the cable and connectors between the electrode, preamplifier and controller is critical. Make sure that all electrical connections stay clean and dry. Never splice the cable prior to preamplification. Replace the cable if there is any sign of damage.

6.3 Replacing the Fuses



CAUTION: Disconnect power to the controller before opening front panel!

Locate the fuses on the circuit board at the back of the controller enclosure. (See figure 4.) Gently remove the old fuse from its retaining clip and discard. Press the new fuse into the clip, secure the front panel of the controller and return power to the unit.

Warning: Use of non-approved fuses can affect product safety approvals. Fuse ratings depend on controller power rating. Specifications are shown below. To insure product safety certifications are maintained, it is recommended that a Walchem fuse be used.

F1 Fuse	Walchem P/N	F2 Fuse	Walchem P/N
5 x 20 mm, 1.0A, 250V	103163	5 x 20 mm, 6A, 250V	102834

7.0 TROUBLESHOOTING



CAUTION: Disconnect power to the controller before opening front panel!

Troubleshooting and repair of a malfunctioning controller should only be attempted by qualified personnel using caution to ensure safety and limit unnecessary further damage. Contact the factory.

7.1 Error Messages

Output Timeout

This error message appears if one of the control outputs has been on longer than the maximum amount of time programmed in the "Time Limit" menu found in the Control menus. It is reset by answering "Yes" to the "Reset Timer" prompt that will appear or by cycling power to the controller off and back on. There are a number of possible reasons that the output could go on for longer than normal:

Possible Cause	Corrective Action
The process went further out of control than normal.	Increase time limit or reset timer.
The chemical supply has run out.	Replenish the chemical supply.
The pump or valve or supply line is faulty.	Repair or replace the control device.
Wrong chemical is being controlled.	Replace with correct chemical.
With a flow-through sensor, the sample pump has failed	Repair or replace the sample pump.
The sensor is not responding to changes.	Replace sensor. Evaluate mixing or recirculation.

No Sample

No sample will be displayed if the measurement signals indicate excess air in the sample. In the mV in Display menu, both the measurement and reference mV currently (the top line) will be lower than the readings were in water during the last New Sensor Setup (displayed on the bottom line).

Possible Cause	Corrective Action
Liquid level too low for immersible sensor	Raise level or lower sensor
Sample pump failure	Repair or replace sample pump
Leak in or blockage of the sample line	Repair sample line
Dirty sensor	Clean or etch sensor
Excess air in sample tubing	Purge sample line of air. Check for leaks. Check orientation of sensor.
Contamination of the bath	A chemical in the bath may be absorbing at the reference wavelength. Test the sensor in a sample of uncontaminated nickel solution.
Faulty sensor	Repair or replace sensor
Controller is faulty; fails self test (see section 5.2)	Repair or replace controller

Light Bulb Out

Light Bulb Out will be displayed if the measurement signals indicate no light. In the mV in Display menu, both the measurement and reference mV currently (the top line) will be less than 1% of what the readings were in water during the last New Sensor Setup (displayed on the bottom line).

Possible Cause	Corrective Action
Sensor wire(s) disconnected	Reconnect.
Lamp failure	Replace lamp
Dirty sensor	Clean or etch sensor
Faulty sensor	Repair or replace sensor.
Controller is faulty; fails self test (see section 5.2)	Repair or replace controller

High Alarm

This error message appears if the nickel sensor reading exceeds the high alarm set point. There are a number of possible causes for this condition:

Possible Cause	Corrective Action
Overshooting set point	Reduce replenishment pump rate. Increase flow rate through the nickel sensor. Place replenishment pump discharge closer to sample tubing inlet.
The sensor is not responding to changes.	Clean, repair or replace sensor. Evaluate mixing or recirculation.
The pump is siphoning, valve leaking.	Repair or replace the control device or re-route tubing.
Output 1 has been left in "HAND" mode.	Switch back to "AUTO".

Low Alarm

This error message appears if the nickel sensor reading is less than the low alarm set point. There are a number of possible causes for this condition:

Possible Cause	Corrective Action
The nickel pump is not working	Repair or replace pump
Nickel chemical supply is empty	Restore nickel chemical supply
Output 1 is in Off mode	Put Output 1 in Auto mode

pH High Alarm

This error message appears if the pH rises above the high alarm set point. This guide assumes that the pH control mode is a Low Set Point (normally feeding ammonia to raise the pH).

Possible Cause	Corrective Action
Overshooting set point	Reduce replenishment pump rate. Increase flow rate past the pH sensor. Place replenishment pump discharge closer to sample tubing inlet.
Pump siphoning	Repair or replace the control device or re-route tubing.
The pH electrode is not responding to changes.	Replace sensor, cable or preamplifier. Evaluate mixing or recirculation.
Output 3 has been left in "HAND" mode.	Switch back to "AUTO".

pH Low Alarm

This error message appears if the pH drops below the low alarm set point. This guide assumes that the pH control mode is a Low Set Point (normally feeding ammonia to raise the pH).

Possible Cause	Corrective Action
The pH pump is not working	Repair or replace pump
Ammonia chemical supply is empty	Restore ammonia chemical supply
Output 3 is in Off mode	Put Output 3 in Auto mode

Sensor Error

This error message appears if the nickel sensor input signal is outside of the normal range. This usually indicates that the sensor has been disconnected or is faulty. It could appear under normal conditions if the nickel concentration is above the operating range of the sensor that is connected (negative measurement mV in Display).

Possible Cause	Corrective Action
New Sensor Setup has not been performed, or performed incorrectly	Perform a New Sensor Setup
Nickel concentration is too high	Reduce nickel to within specifications
Sensor is not connected	Connect sensor. Check wiring inside controller from the sensor receptacle
Condensation inside sensor	Allow sensor to dry out. Replace desiccant.
Faulty sensor receptacle on controller	Replace
Faulty sensor cable or photodetector	Repair or replace sensor
Faulty controller; fails self test	Repair or replace controller

pH Sensor Error

This error message appears if the pH sensor input signal is outside of the normal range. This usually indicates that the sensor has been disconnected or is faulty.

Possible Cause	Corrective Action
The pH sensor is not connected properly	Check wiring
The pH cartridge is defective	Replace pH cartridge
Preamplifier is defective	Replace preamplifier
Faulty controller; fails pH input self test	Repair or replace controller

Temp Error

This error message appears if the pH sensor input temperature signal is outside of the normal range. The PT1000 RTD should read 1000 ohms at 0°C and 3.85 ohms/degree C above zero. At 25°C it should read 1096.25 ohms±1%. The PT100 RTD should read 100 ohms at 0°C and 0.385 ohms/degree C above zero. A higher reading or open circuit (infinite resistance) may indicate a bad connection. A lower reading may indicate a shorted cable.

Possible Cause	Corrective Action
The pH sensor is not connected properly	Check wiring to temperature input
Faulty temperature sensor	Measure resistance and replace sensor if defective

Plate Out

Plate Out will be displayed if the measurement signals indicate a reduction of light. In the mV in Display menu, both the measurement and reference mV currently (the top line) will be less than 40% of what the readings were in water during the last New Sensor Setup (displayed on the bottom line).

Possible Cause	Corrective Action
New Sensor Setup has not been performed, or performed incorrectly	Perform a New Sensor Setup
Dirty sensor	Clean or etch sensor
Faulty sensor receptacle on controller	Replace
Faulty sensor cable or photodetector	Repair or replace sensor
Faulty controller; fails self test	Repair or replace controller

Interlock

This error message indicates that control has been stopped because the closed contact signal from a flow switch or level switch is now open and one or more control outputs have been programmed to interlock.

Possible Cause	Corrective Action
Flow has stopped, level too low.	May be a normal condition, otherwise restore flow or level.
Flow, level switch disconnected.	Reconnect.
Flow, level switch faulty.	Verify that switch closes using an ohmmeter. If not, repair or replace.
Controller faulty.	Verify that error message disappears if controller flow switch input is shorted. If not, repair controller.

Calibration Time

This message appears to prompt you to perform the routine maintenance of cleaning and calibrating the sensor. It does not appear based upon any analysis of the condition of the sensor. The frequency of calibration is set by the user in the "Days Between Cal" menu found in the "Sensor" menu. If you do not want to be prompted to perform a calibration, set this menu to "0".

Out Range Alarm

This error message appears if the sensor reading is outside of the range selected for one of the Control outputs that has been programmed as an "Out of Range Alarm". Refer to the possible causes and corrective actions listed above for the "High Alarm" error message.

In Range Output

This error message appears if the sensor reading is inside of the range selected for one of the Control outputs that has been programmed as an "In Range Alarm". Refer to the possible causes and corrective actions listed above for the "High Alarm" error message.

Turnover Limit

This message appears if you have selected to totalize based upon Metal Turnovers (MTO) and the controller has calculated that the programmed MTO limit has been exceeded. When the bath has been replaced and the total reset, the error message will be cleared.

Control Delay

This message appears on power-up for 30 seconds. In some situations, the user may not want the unit to be controlling and possibly turning on pumps when it is first powered on. This allows you enough time to enter the Output menus and disable the outputs. The only difference in the controller operation during these 30 seconds is that it will not activate any outputs. All measurements are live and all menus are accessible.

Manual Output

This message appears when a relay has been placed into Hand mode. It will remain on the display until the relay is moved back into Automatic or Off mode. The relay will move back to Automatic mode by itself after 10 minutes.

8.0 SERVICE POLICY

The WNI Series Electrodeless Conductivity Controller has a 2-year warranty on electronic components and a 1-year warranty on mechanical parts (keypad, terminal strip and relays).

We stock circuit boards for immediate exchange after we have isolated the cause of the problem.

Factory authorized repairs that are received by next-day-air will be returned within 24 hours. Normal priority for returns is two weeks.

Out of warranty repairs or circuit board exchanges are done on a flat fee basis after the warranty is expired.

FIVE BOYNTON ROAD
TEL: 508-429-1110

HOPPING BROOK PARK
FAX: 508-429-7433

HOLLISTON, MA 01746 USA
Web: www.walchem.com